

WAVE SPRINGS

PRODUCT CATALOG



ABOUT ROTOR CLIP

Rotor Clip is a globally recognized manufacturer of high-quality wave springs, retaining rings, spiral rings, and hose clamps. Founded in 1957 by Robert Slass with a 2,000 square-foot plant in Farmingdale, New York, Rotor Clip has grown to include a 238,000 square-foot headquarters and production facility in Somerset, New Jersey. Companies across a broad range of industries rely on Rotor Clip products, value-added services and expertise to build reliable and safe equipment.

Our skilled staff is committed to continuous innovation and process improvements to help customers meet their production goals. That includes applying their expertise directly with customers to solve difficult problems and ensure they receive the highest-quality, highest-performing products. Throughout the years, Rotor Clip has received numerous quality awards from major OEMs, manufacturers and distributors.

OUR CERTIFICATIONS

AS 9100	IATF 16949	ISO 9001	ISO 14001	ISO 13485	TISAX
------------	---------------	-------------	--------------	--------------	-------

OUR WORLDWIDE LOCATIONS

- Somerset - NJ, United States
(Manufacturing Plant - North America)
- Budyně nad Ohří, Czech Republic
(Manufacturing Plant - Europe)
- Sheffield, United Kingdom
- Idstein, Germany
- Shanghai, China



ROTORCLIP.COM | INFO@ROTORCLIP.COM



Rotor Clip Headquarters, Somerset NJ, USA

QUALITY PRODUCTS THAT MEET BUDGET TARGETS

Our wave springs, retaining rings, and hose clamps are produced solely in the U.S. and Europe in a finely tuned, vertically integrated and lean manufacturing environment that provides for tight controls on quality, lead times, and costs.

With locations across Europe, United States and Asia, Rotor Clip maintains consistent global supply with regional support close to our customers.

Coiling of Multi-Turn Wave Spring



TABLE OF CONTENTS

2

WAVE SPRINGS
the engineering advantage

3

WAVE SPRING
QUALITY ASSURANCE

4 - 7

WAVE SPRING OVERVIEW

- Single Turn
- Multi Turn

8

CUSTOMER SUPPORT

9

CUSTOM WAVE SPRING
DESIGN

10

APPLICATIONS

11 - 17

STANDARD SINGLE TURN
WAVE SPRINGS

SST SERIES - Inch 11 - 12

NST SERIES - Inch, Narrow 13

SRT SERIES - Inch, Round Wire 14

MST SERIES - Metric 15 - 16

MST Bearing Interchange 17

18 - 39

STANDARD MULTI TURN
WAVE SPRINGS

WSL,WSM,WSR SERIES - Inch 18 - 27

MWL,MWM,MWR SERIES - Metric 28 - 39

40 - 41

WAVE SPRING QUOTE
& DESIGN FORM

WAVE SPRINGS - the engineering advantage



Why settle for ordinary springs when wave springs offer optimal force handling, space savings and performance?

Our single-turn and multi-turn wave springs are made from coiled flat or round wire with waves added to give them a spring effect. In many applications, they offer distinct advantages over traditional springs.

Wave springs boast an attractive force-to-work height ratio, typically needing half the work height of coil springs for both axial and radial space savings. They also provide consistent force over a wide range of deflections, transmitting those forces only in the intended axial direction while improving dimensional tolerances. Wave springs do not suffer from torsional loading and twisting that can cause wear.

Additional benefits include increased travel distances and the ability to self-locate in bored holes and shafts, mechanical loads, stand up to corrosion, and perform in extreme temperatures to ensure safe and long lasting application performance.

The Rotor Clip Wave Spring Advantage

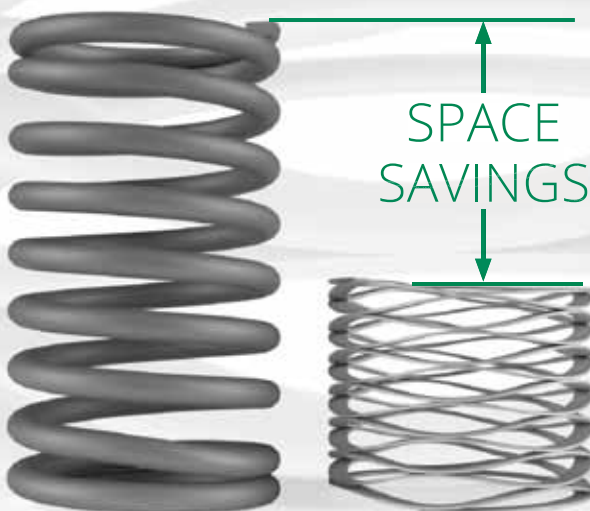

Round Wire
Coil Spring

Flat Wire
Wave Spring

- Up to 50% reduced spring height
- Axial and radial space savings
- Same or greater forces than traditional coil springs
- Same deflection
- **NO MINIMUM ORDER QUANTITY!**



WAVE SPRING QUALITY ASSURANCE

Controlled processes and reliable products our customers can count on.

Quality Spotlight

PRECISION WIRE PRODUCTION



Our laser gauges continuously control the wire dimensions during ongoing production and provide direct notification of tolerance violations providing for in-line quality assurance.

QUALITY PRODUCTS DELIVERED FASTER

Our goal is to continuously produce and deliver high quality, precision wave springs with tight dimensional tolerances that our customers can count on.

In order to meet this goal, Rotor Clip has taken every critical production step and support process in-house. This total vertical integration allows for a very high level of quality control, process optimization, and innovation when it comes to manufacturing high performance wave springs.

QUALITY RAW MATERIAL

We perform multi-point inspection on all incoming batches of raw wire. Our multiple wire mills with no-contact laser gauges ensure only precision wire made from carbon/stainless steel and exotic alloys with very tight tolerances is used in the production of our wave springs to ensure that products are ready to ship in a short period of time.

CONTINUOUS QUALITY MONITORING

During production, our smart coiling machines continuously monitor tooling conditions and product output. Predictive and preventative maintenance measures tie directly to our ERP system reducing machine downtimes and production slow downs. This guarantees maximum production runs, improved Lean manufacturing efforts, reduction in raw material waste and additional quality control.

100% PROCESS AND QUALITY CONTROL

Rotor Clip's integrated manufacturing expertise in conjunction with our in-house quality and metrology labs ensure that our customers receive only high quality wave springs at competitive prices, delivered on time.

CAPABILITIES AND PROCESSES

Full lot traceability on all parts.

In-house quality laboratory:

- » Spring Load Testing to 32,500lbs / 145kN
- » Simultaneous Spring Pre-setting & Load Testing with real time test results
- » Microstructure Analysis
- » Tensile Testing
- » Hardness Testing
- » Salt-Spray Testing
- » Cleanroom for Cleanliness Testing
- » Multi-point Raw Material Inspections

In-house Metrology Laboratory:

- » Surface Roughness Testing
- » Contracting
- » Dimensional Studies via Keyence System

Assembly simulation with 3D printing

Automated Machine Vision Systems for continuous dimensional checks.

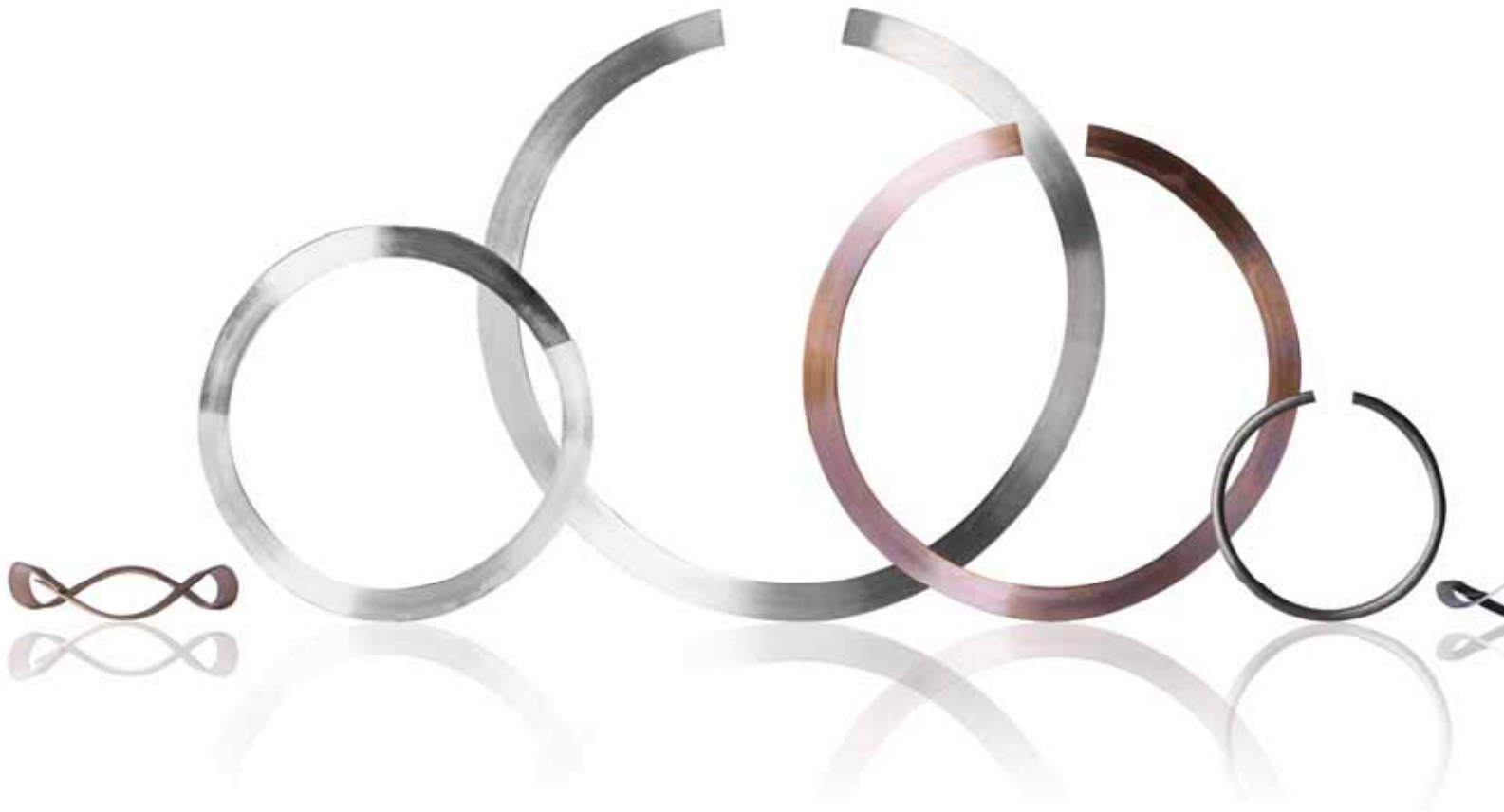

SINGLE-TURN WAVE SPRINGS

Single-turn wave springs are appropriate for a range of light to heavy duty applications with low to high thrust loads depending on design and wire type.

Single-turn wave springs are particularly suited to fit narrow radial wall dimensions and low clearances or to accommodate ball or roller bearings.

Innovation Spotlight

PATENTED FLAT END DESIGN THAT PROTECTS MATING COMPONENTS FROM WEAR TO PROLONG APPLICATION LIFE.



Rotor Clip's patented a single-turn wave spring design protects components, such as bearings by eliminating sharp, damaging corners from the spring ends by flattening them so they rest smoothly against the mating assembly.



Flat ends make parallel contact with the outer race of the bearing.

SST SERIES



SINGLE-TURN, INCH

Ideal for short deflection applications with low to medium forces. Offered in a number of waves and material thicknesses. Designed for a wide range of bore and rod diameters.

SIZE RANGE: 0.5in - 16in

See pages 11 - 12 for full specifications.

NST SERIES



SINGLE-TURN NARROW, INCH

Appropriate where radial space is limited, these wave springs are specified for several standard bearing diameters.

SIZE RANGE: 3.25in - 7.75in

See page 13 for full specifications.

MST SERIES



SINGLE-TURN, METRIC

Ideal for short deflection applications with low to medium forces. Offered in a number of waves and material thicknesses. Designed for a wide range of bore and rod diameters.

SIZE RANGE: 9mm - 580mm

See pages 15 - 16 for full specifications.

SRT SERIES - ROUND WIRE WAVE SPRINGS

SINGLE-TURN ROUND WIRE, INCH

Ideal for use in high load, high rate, low deflection, static, or low cycling applications. Cost effective alternative to disc springs.

SIZE RANGE: 0.5in - 6in



See page 14 for full specifications.

DISC VS ROUND WIRE WAVE SPRING COMPARISON

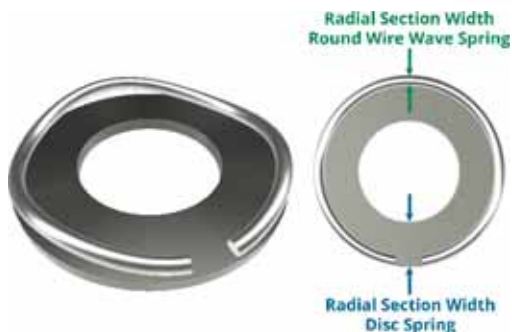

The SRT is a single-turn wave spring coiled from round-section wire instead of the typical wave spring flat wire.

This contributes to increased and more accurate loading compared to alternative spring options like disc springs or Belleville washers, with the advantage of improved load accuracy due to greater deflection and up to 25% reduced radial cavity.

The significantly reduced section width reduces the required radial space, thus benefiting overall component size and weight which can be critical design considerations.

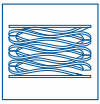

MULTI-TURN WAVE SPRINGS

Compact and robust, multi-turn wave springs are particularly suitable for medium and heavy duty applications or designs requiring high thrust load capacity. They can accommodate a wide variety of loads, deflections and diameters. Multi-turn wave springs typically replace coiled springs or stacks of disc springs. Customers can choose plain or shim ends.

Performance Spotlight

PRECISE AND EVEN SPRING FORCES

In multi-turn wave springs the spring rate is reduced proportionally to the number of turns and a flat linear characteristic can be generated.

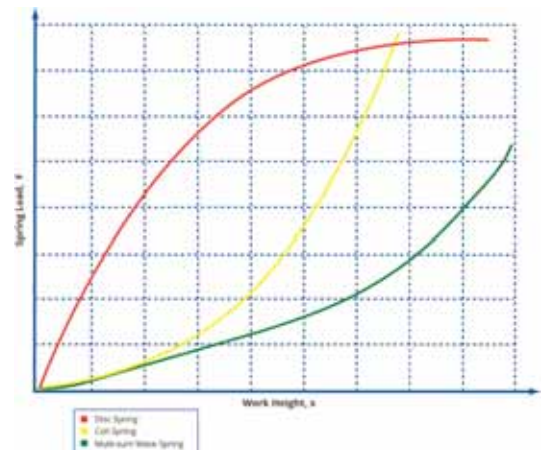



WSL/WSM/WSR SERIES

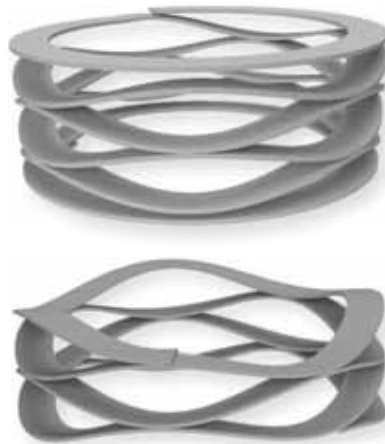

MULTI-TURN, INCH

Used for low to medium force applications with greater travel compared to single-turn springs. Utilizes nearly half the space as helical compression spring while producing the same force.

SIZE RANGE: 0.25in - 2in

WSL = Light

WSM = Medium

WSR = Heavy

See pages 18 - 27 for full specifications.

MWL/MWM/MWR SERIES



MULTI-TURN, METRIC

Used for low to medium force applications with greater travel compared to single-turn springs. Utilizes nearly half the space as helical compression spring while producing the same force.

SIZE RANGE: 5mm - 60mm

MWL = Light

MWM = Medium

MWR = Heavy

See pages 28 - 39 for full specifications.

NESTED WAVE SPRINGS

MULTI-TURN, NESTED

Nested wave springs are multi-turn wave springs with each turn coiled in parallel. This configuration can generate multiple times the spring force of single turn and multiple turn crest-to-trough wave springs.

SIZE RANGE:

0.118in - 25in or 3mm - 635mm



Nested wave springs can provide a higher load than a single-turn version. Although a disc spring can also handle a higher load, nested wave springs occupy less radial space and offer more travel. They also streamline assembly, requiring only one part because users do not need to stack them like single-turn designs, stamped parts or disc springs.



COMPLETE CUSTOMER SUPPORT



Global supply with local support.

Support Spotlight

3D PRINTED APPLICATIONS FOR FASTER TURNAROUND



- In-house testing for fit and function.
- Necessary Product adjustments are made immediately.
- Allows for shorter design cycles.
- Faster delivery of series ready parts to the end-user.

WE ARE HERE FOR YOU

The Rotor Clip team is 500+ strong and supports our global customers from our US headquarters, our European production and logistics hub in the Czech Republic, as well as our strategically placed engineering, sales, and warehousing locations in the UK, Germany, Poland and China. We work very closely with our customers to provide product solutions and services that set new levels of efficiencies today and in the future.

At its core this comes down to us providing you with first class service and technical guidance to find the ring, spring, or clamp that is perfectly matched with your customer's application needs and your financial targets.

CUSTOMER SERVICE

Rotor Clip's key to customer satisfaction is communication and the high level of service and support throughout all aspects of our business.

Our knowledgeable and dedicated customer service professionals are intimately familiar with the individual needs of our customers, providing you with fast answers and long-term solutions that address your concerns.

ENGINEERING SUPPORT

Our technical support team provides you with the answers you seek, including:

- Assistance with Product Selection
- Identification of proper Materials, Finishes and Packaging
- Product Specifications
- Performance Data and Calculations
- In-house Testing
- Rapid Prototyping
- PPAPs

On-demand engineering support services designed around your needs!

TECHNOLOGY SUPPORT

- EDI
- VMI Portals
- Free Access to Rotor Clip's Online Portal for easy 24/7 self service.
- Online Access to the latest product data, CAD models, and prints.
- We provide clean and up to date product data for your internal systems.



CUSTOM WAVE SPRING DESIGN ASSISTANCE

Interested in finding out if a wave spring can empower your design?



WE ARE HERE FOR YOU

Rotor Clip's application engineers are available to assist you with finding or developing the perfect wave spring for your individual application needs and will support you from initial concept through series production.

The easiest way to start is by filling out the included wave spring design and quote form on pages 40 and 41 or use our on-line wave spring calculator.

WAVE SPRING QUOTE & DESIGN FORM

Rotor Clip offers a wide range of standard metric and inch size flat wire wave springs with one or multiple turns.

Depending on the requirements of each customer's application, we determine if there is a suitable spring available from our standard program or if a custom spring design is necessary.

Using the following selection criteria one can easily determine which spring type best meets the application requirements:

BORE / SHAFT DIAMETER

RADIAL GUIDE / PILOT

LOAD SPECIFICATIONS

CYCLE LIFE

OPERATING CONDITIONS

SPRING TYPE

MATERIAL

FINISH

VOLUME

DELIVERY TIME

ONLINE WAVE SPRING CALCULATOR

The custom wave spring calculator allows the input of basic spring/ application parameters and returns either a reference drawing to submit for quotation or an error message if the spring is not feasible. Design engineers should know right away if their design or application needs to be adjusted, allowing them to fine tune a nearly-finished product with your application engineer.

The calculator can be found online:
www.rotorclip.com/wsc

SIZE RANGES

- Custom wave springs range from .118 - 25" or 3 - 635mm.

STANDARD MATERIALS

- Carbon steel
SAE 1060-1090 (ST)
- 17-7 Stainless Steel (SS)

SPECIALTY MATERIAL GRADES

- Stainless - AISI 316
- Stainless - A286
- Inconel X-750
- Elgiloy
- Hastelloy C276
- Beryllium-copper
- Phosphor-bronze

FINISHES

- Oil dip (Carbon Steel)
- Passivation (Stainless Steel)

PACKAGING

- Shrink wrapped
- Loose bulk

APPLICATIONS



MULTI-TURN WAVE SPRING
in Downhole Tool

In many applications, flat wire wave springs offer significant advantages over traditional spring elements such as coil or disc springs.

MULTI-TURN WAVE SPRING
in Fluid Connector

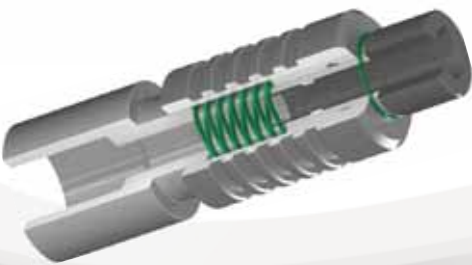

SINGLE-TURN WAVE SPRING
in Quick Connector



SINGLE-TURN WAVE SPRING
in Steering Motor

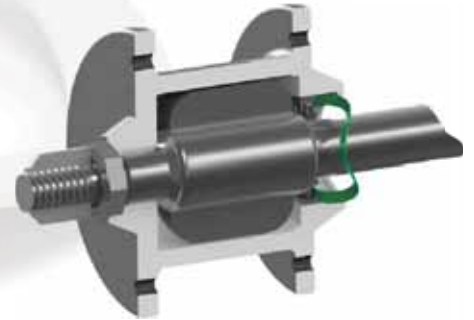

SINGLE-TURN WAVE SPRING
in Sensor Retention and Preload



SINGLE-TURN WAVE SPRING
in Ultra Sonic Motor



MULTI-TURN WAVE SPRING
in Sideview Mirror



MULTI-TURN WAVE SPRING
in Fishing Reel

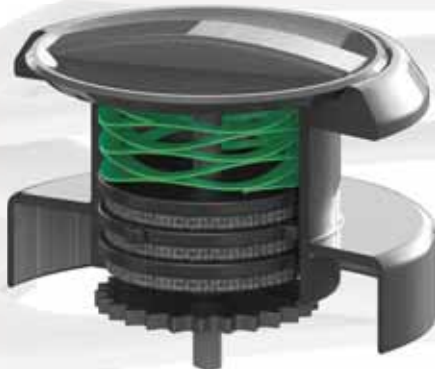

MULTI-TURN WAVE SPRING
in Injection Pen



MULTI-TURN WAVE SPRING
in Mechanical Seal





SST WAVE SPRINGS

Single Turn, Inch

Ideal for short deflection applications with low to medium forces.

Offered in a number of waves and material thicknesses.

Designed for a wide range of bore and rod diameters.

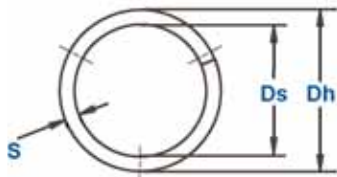

Overlap: Sizes -50 to -162
3 Waves

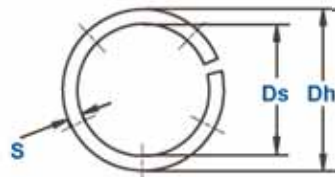

Gap: Sizes -175 & up
*Multiple Waves (see table)

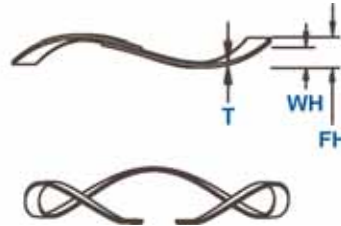

Patented Optional End Design

WAVE SPRING NO.	OPERATES IN HOUSING DIAMETER	SHAFT DIAMETER CLEARANCE	LOAD (lb)	WORK HEIGHT	FREE HEIGHT Ref.	NUMBER OF WAVES	THICKNESS	SECTION	SPRING RATE Ref.
	Dh	Ds		WH	FH		T	S	lb/in.
SST-50	.500	.400	7	.050	.085	3	.008	.040	200
SST-62	.625	.480	10	.050	.095	3	.010	.058	222
SST-75	.750	.500	14	.062	.160	3	.010	.078	143
SST-87	.875	.620	16	.062	.130	3	.012	.094	235
SST-100	1.000	.780	18	.062	.160	3	.012	.094	184
SST-112	1.125	.840	20	.078	.130	3	.016	.133	385
SST-125	1.250	.960	22	.078	.150	3	.016	.133	306
SST-137	1.375	1.090	24	.078	.190	3	.016	.133	214
SST-150	1.500	1.170	26	.078	.170	3	.018	.143	283
SST-162	1.625	1.310	28	.078	.200	3	.018	.143	230
SST-175	1.750	1.440	30	.078	.140	4	.018	.143	484
SST-187	1.875	1.560	32	.078	.150	4	.018	.143	444
SST-200	2.000	1.680	34	.093	.140	4	.024	.150	723
SST-212	2.125	1.800	36	.093	.150	4	.024	.150	632
SST-225	2.250	1.930	38	.093	.170	4	.024	.150	494
SST-237	2.375	1.990	40	.093	.160	4	.024	.178	597
SST-250	2.500	2.120	42	.093	.170	4	.024	.178	545
SST-262	2.625	2.240	44	.093	.190	4	.024	.178	454
SST-275	2.750	2.340	46	.109	.170	4	.030	.188	754
SST-287	2.875	2.470	48	.109	.180	4	.030	.188	676
SST-300	3.000	2.590	50	.109	.190	4	.030	.188	617
SST-312	3.125	2.710	52	.109	.210	4	.030	.188	515
SST-325	3.250	2.750	54	.109	.200	4	.030	.233	593
SST-337	3.375	2.840	56	.109	.220	4	.030	.233	505
SST-350	3.500	3.000	58	.109	.230	4	.030	.233	479
SST-362	3.625	3.120	60	.109	.240	4	.030	.233	458
SST-375	3.750	3.250	62	.109	.260	4	.030	.233	411
SST-387	3.875	3.370	64	.109	.300	4	.030	.233	335
SST-400	4.000	3.500	66	.109	.190	5	.030	.233	815
SST-412	4.125	3.620	67	.109	.200	5	.030	.233	736
SST-425	4.250	3.740	69	.109	.210	5	.030	.233	683
SST-437	4.375	3.860	70	.109	.210	5	.030	.233	693
SST-450	4.500	3.990	72	.109	.230	5	.030	.233	595
SST-462	4.625	4.110	73	.125	.270	5	.030	.233	503
SST-475	4.750	4.240	75	.125	.310	5	.030	.233	405
SST-487	4.875	4.370	76	.125	.290	5	.030	.233	461

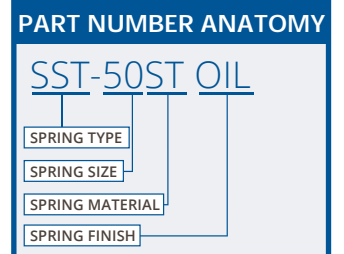

When ordering, parts should be presented with the part number, followed by the material. (i.e. SST-50ST, SST-75SQ)

Standard Material Codes:
 ST = carbon steel.
 SQ = 17-7 PH/C stainless steel.
 Special alloys available upon request.



SST WAVE SPRINGS

Single Turn, Inch

Ideal for short deflection applications with low to medium forces.

Offered in a number of waves and material thicknesses.

Designed for a wide range of bore and rod diameters.

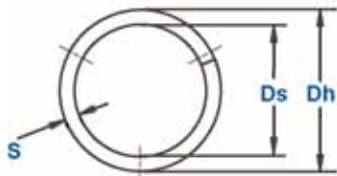

Overlap: Sizes -50 to -162
3 Waves

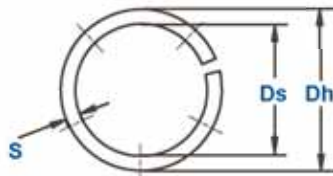

Gap: Sizes -175 & up
*Multiple Waves (see table)

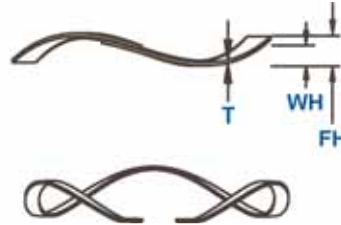

Patented Optional End Design

WAVE SPRING NO.	OPERATES IN HOUSING DIAMETER	SHAFT DIAMETER CLEARANCE	LOAD (lb)	WORK HEIGHT	FREE HEIGHT Ref.	NUMBER OF WAVES	THICKNESS	SECTION	SPRING RATE Ref.
	Dh	Ds		WH	FH		T	S	
SST-500	5.000	4.490	78	.125	.310	5	.030	.233	422
SST-512	5.125	4.610	80	.125	.340	5	.030	.233	372
SST-525	5.250	4.740	82	.125	.370	5	.030	.233	335
SST-537	5.375	4.860	84	.125	.380	5	.030	.233	329
SST-550	5.500	4.990	86	.125	.250	6	.030	.233	688
SST-562	5.625	5.110	88	.125	.270	6	.030	.233	607
SST-575	5.750	5.240	90	.125	.280	6	.030	.233	581
SST-587	5.875	5.360	92	.125	.300	6	.030	.233	526
SST-600	6.000	5.490	94	.125	.300	6	.030	.233	537
SST-612	6.125	5.610	96	.125	.310	6	.030	.233	519
SST-625	6.250	5.730	98	.125	.340	6	.030	.233	456
SST-637	6.375	5.860	100	.125	.350	6	.030	.233	444
SST-650	6.500	5.980	102	.125	.390	6	.030	.233	385
SST-675	6.750	6.230	104	.125	.420	6	.030	.233	353
SST-700	7.000	6.160	106	.156	.320	6	.032	.375	646
SST-725	7.250	6.440	108	.156	.350	6	.032	.375	557
SST-750	7.500	6.690	110	.156	.360	6	.032	.375	539
SST-775	7.750	6.940	114	.156	.380	6	.032	.375	509
SST-800	8.000	7.190	118	.156	.390	6	.032	.375	504
SST-825	8.250	7.440	122	.156	.430	6	.032	.375	445
SST-850	8.500	7.680	126	.156	.340	7	.032	.375	685
SST-875	8.750	7.930	130	.156	.340	7	.032	.375	707
SST-900	9.000	8.180	134	.156	.290	8	.032	.375	1,000
SST-950	9.500	8.680	142	.156	.240	9	.032	.375	1,690
SST-1000	10.000	9.170	150	.156	.290	9	.032	.375	1,119
SST-1050	10.500	9.670	158	.156	.310	9	.032	.375	1,026
SST-1100	11.000	10.170	166	.156	.350	9	.032	.375	856
SST-1150	11.500	10.660	174	.156	.360	9	.032	.375	853
SST-1200	12.000	11.160	182	.156	.440	9	.032	.375	641
SST-1250	12.500	11.660	190	.156	.350	10	.032	.375	979
SST-1300	13.000	12.160	198	.156	.410	10	.032	.375	780
SST-1350	13.500	12.650	206	.156	.430	10	.032	.375	752
SST-1400	14.000	13.150	214	.156	.300	12	.032	.375	1,486
SST-1450	14.500	13.650	221	.156	.320	12	.032	.375	1,348
SST-1500	15.000	14.130	230	.156	.350	12	.032	.375	1,186
SST-1550	15.500	14.640	239	.156	.310	13	.032	.375	1,552
SST-1600	16.000	15.140	248	.156	.340	13	.032	.375	1,348

PART NUMBER ANATOMY

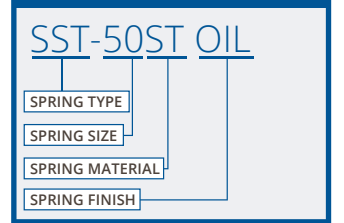

When ordering, parts should be presented with the part number, followed by the material. (i.e. SST-50ST, SST-75SQ)

Standard Material Codes:

- ST = carbon steel.
- SQ = 17-7 PH/C stainless steel.
- Special alloys available upon request.



NST WAVE SPRINGS



Single Turn, Narrow, Inch

Appropriate where radial space is limited, these wave springs are specified for several standard bearing diameters.

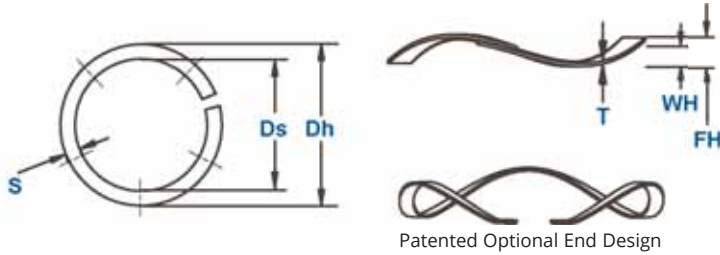

WAVE SPRING NO.	OPERATES IN HOUSING DIAMETER	SHAFT DIAMETER CLEARANCE	LOAD (lb)	WORK HEIGHT	FREE HEIGHT Ref.	NUMBER OF WAVES	THICKNESS	SECTION	SPRING RATE Ref.
	Dh	Ds		WH	FH		T	S	lb/in.
NST-325	3.250	2.820	54	.109	.200	4	.03	.188	593
NST-337	3.375	2.940	56	.109	.220	4	.03	.188	505
NST-350	3.500	3.070	58	.109	.260	4	.03	.188	384
NST-362	3.625	3.190	60	.109	.270	4	.03	.188	373
NST-375	3.750	3.320	62	.109	.280	4	.03	.188	363
NST-387	3.875	3.440	64	.109	.310	4	.03	.188	318
NST-400	4.000	3.570	66	.109	.200	5	.03	.188	725
NST-412	4.125	3.690	67	.109	.200	5	.03	.188	736
NST-425	4.250	3.820	69	.109	.240	5	.03	.188	527
NST-437	4.375	3.940	70	.109	.210	5	.03	.188	693
NST-450	4.500	4.070	72	.109	.280	5	.03	.188	421
NST-462	4.625	4.190	73	.125	.270	5	.03	.188	503
NST-475	4.750	4.320	75	.125	.320	5	.03	.188	385
NST-487	4.875	4.440	76	.125	.320	5	.03	.188	390
NST-500	5.000	4.570	78	.125	.350	5	.03	.188	347
NST-512	5.125	4.690	80	.125	.350	5	.03	.188	356
NST-525	5.250	4.820	82	.125	.360	5	.03	.188	349
NST-537	5.375	4.940	84	.125	.440	5	.03	.188	267
NST-550	5.500	5.070	86	.125	.280	6	.03	.188	555
NST-562	5.625	5.190	88	.125	.290	6	.03	.188	533
NST-575	5.750	5.320	90	.125	.340	6	.03	.188	419
NST-587	5.875	5.440	92	.125	.340	6	.03	.188	428
NST-600	6.000	5.570	94	.125	.340	6	.03	.188	437
NST-612	6.125	5.690	96	.125	.280	7	.03	.188	619
NST-625	6.250	5.820	98	.125	.280	7	.03	.188	632
NST-637	6.375	5.940	100	.125	.300	7	.03	.188	571
NST-650	6.500	6.070	102	.125	.300	7	.03	.188	583
NST-675	6.750	6.320	104	.125	.300	7	.03	.188	594
NST-700	7.000	6.480	106	.156	.320	7	.03	.233	646
NST-725	7.250	6.730	108	.156	.330	7	.03	.233	621
NST-750	7.500	6.980	110	.156	.360	7	.03	.233	539
NST-775	7.750	7.230	114	.156	.380	7	.03	.233	509

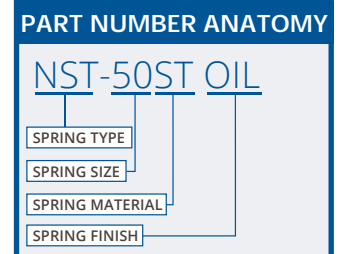

When ordering, parts should be presented with the part number, followed by the material. (i.e. NST-325ST, NST-350SQ)

Standard Material Codes:

- ST = carbon steel.
- SQ = 17-7 PH/C stainless steel.
- Special alloys available upon request.

SRT WAVE SPRINGS



Single Turn, Round Wire, Inch

Ideal for use in high load, high rate, low deflection, static, or low cycling applications. Cost effective alternative to disc springs.

WAVE SPRING NO.	OPERATES IN HOUSING DIAMETER	SHAFT DIAMETER CLEARANCE	LOAD (lb)	WORK HEIGHT	FREE HEIGHT Ref.	NUMBER OF WAVES	SECTION	SPRING RATE Ref.
	Dh	Ds		WH	FH		s	
SRT-50	0.500	0.408	35	0.052	0.062	3	0.031	3500
SRT-62	0.625	0.517	50	0.064	0.077	3	0.038	3846
SRT-75	0.750	0.628	70	0.076	0.092	3	0.045	4375
SRT-87	0.875	0.740	80	0.086	0.104	3	0.051	4444
SRT-100	1.000	0.855	90	0.095	0.116	3	0.056	4286
SRT-112	1.125	0.967	100	0.102	0.127	3	0.060	4000
SRT-125	1.250	1.081	110	0.110	0.138	3	0.065	3929
SRT-137	1.375	1.223	120	0.095	0.121	4	0.056	4615
SRT-150	1.500	1.339	130	0.102	0.128	4	0.060	5000
SRT-162	1.625	1.444	140	0.110	0.137	4	0.065	5185
SRT-175	1.750	1.564	150	0.113	0.144	4	0.067	4839
SRT-187	1.875	1.682	160	0.119	0.155	4	0.070	4444
SRT-200	2.000	1.803	170	0.124	0.165	4	0.072	4146
SRT-212	2.125	1.906	180	0.129	0.162	4	0.076	5455
SRT-225	2.250	2.023	190	0.136	0.168	4	0.080	5938
SRT-237	2.375	2.141	200	0.141	0.178	4	0.083	5405
SRT-250	2.500	2.261	210	0.144	0.185	4	0.085	5122
SRT-262	2.625	2.374	220	0.153	0.203	4	0.090	4400
SRT-275	2.750	2.497	230	0.154	0.212	4	0.091	3966
SRT-287	2.875	2.618	240	0.158	0.210	4	0.093	4615
SRT-300	3.000	2.767	250	0.141	0.179	5	0.083	6579
SRT-312	3.125	2.878	260	0.144	0.184	5	0.085	6500
SRT-325	3.250	2.992	270	0.153	0.190	5	0.090	7297
SRT-337	3.375	3.115	280	0.154	0.195	5	0.091	6829
SRT-350	3.500	3.236	290	0.158	0.201	5	0.093	6744
SRT-362	3.625	3.356	300	0.161	0.206	5	0.095	6667
SRT-375	3.750	3.475	310	0.166	0.212	5	0.098	6739
SRT-387	3.875	3.595	320	0.170	0.208	5	0.100	8421
SRT-400	4.000	3.718	330	0.170	0.225	5	0.100	6000
SRT-412	4.125	3.827	335	0.175	0.221	5	0.105	7283
SRT-425	4.250	3.948	345	0.178	0.225	5	0.105	7340
SRT-437	4.375	4.063	350	0.187	0.240	5	0.110	6604
SRT-450	4.500	4.185	360	0.187	0.247	5	0.110	6000
SRT-462	4.625	4.310	365	0.187	0.253	5	0.110	5530
SRT-475	4.750	4.431	375	0.190	0.257	5	0.112	5597
SRT-487	4.875	4.555	380	0.190	0.264	5	0.112	5135
SRT-500	5.000	4.672	390	0.195	0.265	5	0.116	5571
SRT-512	5.125	4.772	400	0.200	0.274	5	0.118	5405
SRT-525	5.250	4.893	410	0.204	0.279	5	0.120	5467
SRT-537	5.375	5.037	420	0.187	0.245	6	0.110	7241
SRT-550	5.500	5.162	430	0.187	0.251	6	0.110	6719
SRT-562	5.625	5.283	440	0.190	0.245	6	0.112	8000
SRT-575	5.750	5.406	450	0.190	0.251	6	0.112	7377
SRT-587	5.875	5.524	460	0.197	0.262	6	0.116	7077
SRT-600	6.000	5.644	470	0.200	0.268	6	0.118	6912

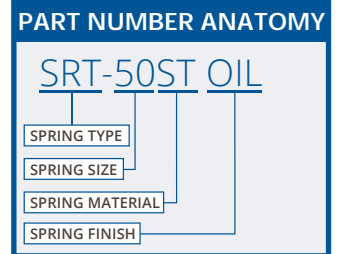
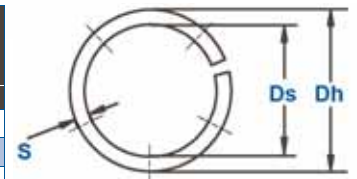

When ordering, parts should be presented with the part number, followed by the material. (i.e. SRT-50ST, SRT-75SQ)

Standard Material Codes:

ST = carbon steel.
 SQ = 17-7 PH/C stainless steel.
 Special alloys available upon request.



MST WAVE SPRINGS

Single Turn, Metric

Ideal for short deflection applications with low to medium forces.

Offered in a number of waves and material thicknesses.

Designed for a wide range of bore and rod diameters.

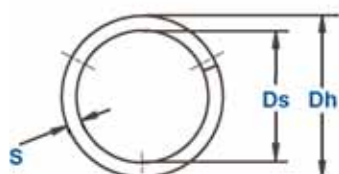

Overlap: Sizes -35 to -374
3 Waves

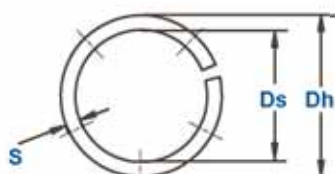

Gap: Sizes -394 & up
*Multiple Waves (see table)

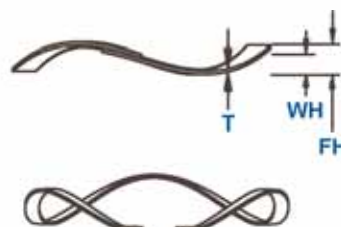

Patented Optional End Design

WAVE SPRING NO.	OPERATES IN HOUSING DIAMETER	SHAFT DIAMETER CLEARANCE	LOAD (N)	WORK HEIGHT	FREE HEIGHT Ref.	NUMBER OF WAVES	THICKNESS	SECTION	SPRING RATE Ref.
	Dh	Ds		WH	FH		T	S	N/mm
MST-35	9,0	6,86	25,8	1,00	1,50	3	0,20	0,81	52
MST-39	10,0	7,49	27,6	1,00	1,57	3	0,20	1,02	48
MST-43	11,0	8,46	29,4	1,00	1,83	3	0,20	1,02	35
MST-47	12,0	9,17	33,4	1,00	1,57	3	0,25	1,17	59
MST-51	13,0	9,53	37,8	1,00	1,57	3	0,25	1,47	66
MST-63	16,0	11,28	44,5	1,57	2,29	3	0,25	1,98	65
MST-75	19,0	14,28	53,4	1,57	3,05	3	0,25	1,98	35
MST-87	22,0	16,46	62,3	1,57	2,79	3	0,30	2,39	48
MST-95	24,0	18,46	66,7	1,57	3,56	3	0,30	2,39	35
MST-102	26,0	18,22	71,2	1,98	2,54	3	0,41	3,38	111
MST-110	28,0	20,22	75,6	1,98	2,79	3	0,41	3,38	85
MST-118	30,0	22,22	84,5	1,98	3,30	3	0,41	3,38	66
MST-126	32,0	24,22	89,0	1,98	3,81	3	0,41	3,38	52
MST-138	35,0	27,22	97,9	1,98	4,57	3	0,41	3,38	38
MST-146	37,0	28,72	102,3	1,98	3,81	3	0,46	3,63	58
MST-158	40,0	31,72	111,2	1,98	5,08	3	0,46	3,63	37
MST-165	42,0	33,72	115,7	1,98	3,05	4	0,46	3,63	99
MST-185	47,0	38,72	129,0	1,98	3,81	4	0,46	3,63	68
MST-205	52,0	43,11	142,4	2,36	3,56	4	0,61	3,76	121
MST-217	55,0	46,11	151,3	2,36	3,81	4	0,61	3,76	100
MST-244	62,0	51,69	169,1	2,36	4,32	4	0,61	4,52	85
MST-268	68,0	57,17	186,9	2,77	4,32	4	0,76	4,78	131
MST-276	70,0	59,17	191,3	2,77	4,32	4	0,76	4,78	119
MST-284	72,0	61,17	195,8	2,77	4,57	4	0,76	4,78	108
MST-295	75,0	64,17	204,7	2,77	5,08	4	0,76	4,78	94
MST-315	80,0	68,66	218,0	2,77	5,59	4	0,76	4,78	76
MST-335	85,0	71,38	231,4	2,77	5,59	4	0,76	5,92	83
MST-354	90,0	76,38	249,2	2,77	6,35	4	0,76	5,92	68
MST-374	95,0	81,38	262,5	2,77	7,37	4	0,76	5,92	57
MST-394	100,0	86,38	275,9	2,77	4,57	5	0,76	5,92	157
MST-413	105,0	91,38	289,2	2,77	5,08	5	0,76	5,92	134
MST-433	110,0	96,38	302,6	2,77	5,33	5	0,76	5,92	115
MST-453	115,0	101,38	315,9	3,18	6,35	5	0,76	5,92	99
MST-472	120,0	106,38	329,3	3,18	7,11	5	0,76	5,92	86
MST-492	125,0	111,38	342,6	3,18	7,62	5	0,76	5,92	76
MST-512	130,0	116,38	356,0	3,18	8,64	5	0,76	5,92	67
MST-532	135,0	121,38	369,3	3,18	9,40	5	0,76	5,92	59
MST-551	140,0	126,38	382,7	3,18	6,86	6	0,76	5,92	108
MST-571	145,0	131,38	396,0	3,18	7,37	6	0,76	5,92	97
MST-591	150,0	136,38	404,9	3,18	7,87	6	0,76	5,92	87
MST-630	160,0	146,38	440,5	3,18	9,40	6	0,76	5,92	71
MST-650	165,0	151,38	453,9	3,18	10,41	6	0,76	5,92	64
MST-669	170,0	156,38	467,2	3,18	11,18	6	0,76	5,92	58

PART NUMBER ANATOMY

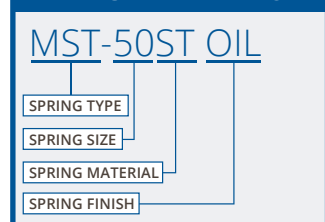

When ordering, parts should be presented with the part number, followed by the material. (i.e. MST-50ST, MST-75SQ)

Standard Material Codes:

- ST = carbon steel.
- SQ = 17-7 PH/C stainless steel.
- Special alloys available upon request.

ALL DIMENSIONS IN MILLIMETERS UNLESS OTHERWISE SPECIFIED.

ALL DIMENSIONS IN MILLIMETERS UNLESS OTHERWISE SPECIFIED.



MST WAVE SPRINGS

Single Turn, Metric

Ideal for short deflection applications with low to medium forces.

Offered in a number of waves and material thicknesses.

Designed for a wide range of bore and rod diameters.

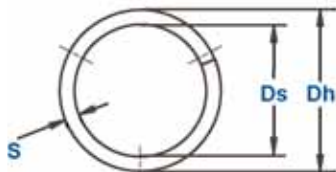

Overlap: Sizes -35 to -374
3 Waves

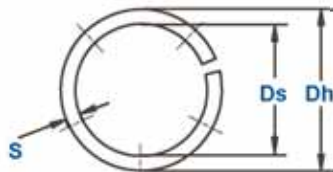

Gap: Sizes -394 & up
*Multiple Waves (see table)

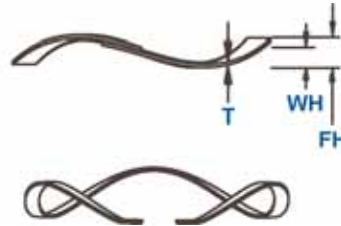

Patented Optional End Design

WAVE SPRING NO.	OPERATES IN HOUSING DIAMETER	SHAFT DIAMETER CLEARANCE	LOAD (N)	WORK HEIGHT	FREE HEIGHT Ref.	NUMBER OF WAVES	THICKNESS	SECTION	SPRING RATE Ref.
	Dh	Ds		WH	FH		T	S	N/mm
MST-689	175,0	154,16	480,6	3,96	8,13	6	0,81	9,53	116
MST-709	180,0	159,16	493,9	3,96	8,64	6	0,81	9,53	105
MST-728	185,0	164,16	507,3	3,96	9,14	6	0,81	9,53	97
MST-748	190,0	169,16	520,6	3,96	9,91	6	0,81	9,53	88
MST-787	200,0	179,16	547,3	3,96	7,11	7	0,81	9,53	174
MST-807	205,0	184,16	560,7	3,96	7,37	7	0,81	9,53	161
MST-827	210,0	189,16	578,5	3,96	7,87	7	0,81	9,53	149
MST-847	215,0	194,16	591,8	3,96	8,38	7	0,81	9,53	138
MST-866	220,0	199,16	605,2	3,96	8,64	7	0,81	9,53	128
MST-886	225,0	204,16	618,5	3,96	7,11	8	0,81	9,53	203
MST-906	230,0	209,16	631,9	3,96	6,10	9	0,81	9,53	303
MST-925	235,0	214,16	645,2	3,96	6,35	9	0,81	9,53	283
MST-945	240,0	219,16	658,6	3,96	6,35	9	0,81	9,53	265
MST-984	250,0	229,16	685,3	3,96	6,86	9	0,81	9,53	232
MST-1024	260,0	239,16	712,0	3,96	7,37	9	0,81	9,53	205
MST-1043	265,0	244,16	725,3	3,96	7,62	9	0,81	9,53	193
MST-1063	270,0	249,16	743,1	3,96	8,13	9	0,81	9,53	182
MST-1102	280,0	259,16	769,8	3,96	8,64	9	0,81	9,53	162
MST-1142	290,0	269,16	796,5	3,96	9,40	9	0,81	9,53	144
MST-1181	300,0	279,16	823,2	3,96	10,41	9	0,81	9,53	129
MST-1221	310,0	289,16	849,9	3,96	7,11	9	1,07	9,53	264
MST-1260	320,0	299,16	876,6	3,96	7,62	9	1,07	9,53	239
MST-1339	340,0	319,16	934,5	3,96	8,64	9	1,07	9,53	198
MST-1378	350,0	329,16	961,1	3,96	9,40	9	1,07	9,53	180
MST-1417	360,0	339,16	987,9	3,96	7,62	10	1,07	9,53	271
MST-1457	370,0	349,16	1014,6	3,96	8,13	10	1,07	9,53	249
MST-1496	380,0	359,16	1041,3	3,96	8,64	10	1,07	9,53	229
MST-1535	390,0	369,16	1072,4	3,96	9,14	10	1,07	9,53	211
MST-1575	400,0	379,16	1099,1	3,96	9,65	10	1,07	9,53	196
MST-1614	410,0	382,82	1125,8	3,96	8,38	10	1,07	12,70	251
MST-1654	420,0	392,82	1152,5	3,96	8,89	10	1,07	12,70	233
MST-1693	430,0	402,82	1179,2	3,96	7,62	11	1,07	12,70	317
MST-1732	440,0	412,82	1205,9	3,96	8,13	11	1,07	12,70	295
MST-1811	460,0	432,82	1263,7	3,96	8,89	11	1,07	12,70	256
MST-1890	480,0	452,82	1317,1	3,96	8,13	12	1,07	12,70	318
MST-1969	500,0	472,82	1370,5	3,96	8,89	12	1,07	12,70	280
MST-2126	540,0	512,82	1481,8	3,96	8,89	13	1,07	12,70	303
MST-2284	580,0	552,82	1593,0	3,96	8,89	14	1,07	12,70	327

PART NUMBER ANATOMY

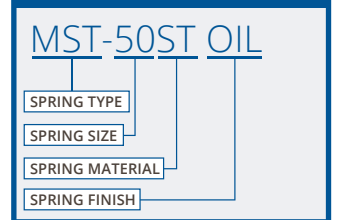

When ordering, parts should be presented with the part number, followed by the material. (i.e. MST-50ST, MST-75SQ)

Standard Material Codes:

- ST = carbon steel.
- SQ = 17-7 PH/C stainless steel.
- Special alloys available upon request.

ALL DIMENSIONS IN MILLIMETERS UNLESS OTHERWISE SPECIFIED.



MST BEARING INTERCHANGE CHART

This chart pairs MST metric, single turn wave springs with the appropriate standard bearing number.

The bearing preload process eliminates unwanted clearances, creates high stiffness, and reduces noise and vibration which increases bearing and application life. Wave springs provide an even load / force with small tolerances due to even, sinusoidal waves in the spring design.

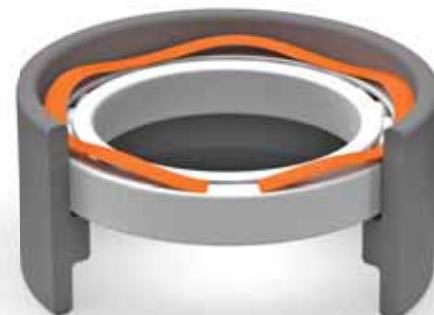

WAVE SPRING NO.	BEARING O.D. mm	BEARING NUMBERS							WAVE SPRING NO.	BEARING O.D. mm	BEARING NUMBERS							
		EXTRA SMALL	EXTREMELY LIGHT	EXTRA LIGHT	NARROW	LIGHT	MEDIUM	HEAVY			EXTRA SMALL	EXTREMELY LIGHT	EXTRA LIGHT	NARROW	LIGHT	MEDIUM	HEAVY	
MST-35	9	03,18/4	-	-	-	-	-	-	MST-650	165	-	24	-	20	-	-	-	
MST-39	10	23	-	-	-	-	-	-	MST-669	170	-	-	122	-	219	316	-	
MST-43	11	18/5,19,4	-	-	-	-	-	-	MST-689	175	-	-	-	22	-	-	-	
MST-47	12	4	-	-	-	-	-	-	MST-709	180	-	26	124	21	220	317	414	
MST-51	13	18/6,19/5,24,33	-	-	-	-	-	-	MST-728	185	-	-	-	22	-	-	-	
MST-63	16	34	-	-	-	-	-	-	MST-748	190	-	28	-	24	221	318	415	
MST-75	19	35,36	-	-	-	-	-	-	MST-787	200	-	-	126	-	222	319	416	
MST-87	22	37,38	00	-	-	-	-	-	MST-807	205	-	-	-	26	-	-	-	
MST-95	24	38KV	01	-	-	-	-	-	MST-827	210	-	30	128	-	-	-	417	
MST-102	26	39	-	100	-	-	-	-	MST-847	215	-	-	-	-	224	320	-	
MST-110	28	-	02	101	-	-	-	-	MST-866	220	-	32	-	28	-	-	-	
MST-118	30	-	03	-	-	200	-	-	MST-886	225	-	-	130	-	-	321	418	
MST-126	32	-	-	102	02	201	-	-	MST-906	230	-	34	-	-	226	-	-	
MST-138	35	-	-	103	-	202	300	-	MST-925	235	-	-	-	30	-	-	-	
MST-146	37	-	04	-	03	-	301	-	MST-945	240	-	-	132	-	-	322	-	
MST-158	40	-	-	-	-	203	-	-	MST-984	250	-	36	-	32	228	-	419	
MST-165	42	-	05	104	04	-	302	-	MST-1024	260	-	38	134	-	-	324	-	
MST-185	47	-	06	105	-	204	303	-	MST-1043	265	-	-	-	34	-	-	420	
MST-205	52	-	-	-	05	205	304	-	MST-1063	270	-	-	-	-	230	-	-	
MST-217	55	-	07	106	-	-	-	-	MST-1102	280	-	40	136	36	-	326	-	
MST-244	62	-	08	107	06	206	305	403	MST-1142	290	-	-	138	-	232	-	421	
MST-268	68	-	09	108	-	-	-	-	MST-1181	300	-	-	-	38	-	328	-	
MST-276	70	-	-	-	07	-	-	-	MST-1221	310	-	-	140	-	234	-	-	
MST-284	72	-	10	-	-	207	306	404	MST-1260	320	-	-	-	40	236	330	422	
MST-295	75	-	-	109	-	-	-	-	MST-1339	340	-	-	144	42	238	332	-	
MST-315	80	-	11	110	08	208	307	405	MST-1378	350	-	-	-	44	-	-	-	
MST-335	85	-	12	-	09	209	-	-	MST-1417	360	-	-	148	-	240	334	-	
MST-354	90	-	13	111	10	210	308	406	MST-1457	370	-	-	-	46	-	-	-	
MST-374	95	-	-	112	-	-	-	-	MST-1496	380	-	-	-	-	-	336	-	
MST-394	100	-	14	113	11	211	309	407	MST-1535	390	-	-	-	48	-	-	-	
MST-413	105	-	15	-	12	-	-	-	MST-1575	400	-	-	152	-	244	338	-	
MST-433	110	-	16	114	-	212	310	408	MST-1614	410	-	-	-	50	-	-	-	
MST-453	115	-	-	115	13	-	-	-	MST-1654	420	-	-	156	-	-	340	-	
MST-472	120	-	17	-	14	213	311	409	MST-1693	430	-	-	-	52	-	-	-	
MST-492	125	-	18	116	-	214	-	-	MST-1732	440	-	-	-	-	248	342	-	
MST-512	130	-	19	117	15	215	312	410	MST-1811	460	-	15	-	160	56	-	344	-
MST-532	135	-	-	-	16	-	-	-	MST-1890	480	-	-	164	-	252	-	-	-
MST-551	140	-	20	118	-	216	313	411	MST-1969	500	-	-	-	64	256	348	-	
MST-571	145	-	21	119	17	-	-	-	MST-2126	540	-	-	-	-	260	352	-	
MST-591	150	-	22	120	18	217	314	412	MST-2284	580	-	-	-	-	264	356	-	
MST-630	160	-	-	121	19	218	315	413										

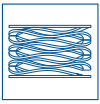

WSL, WSM, WSR WAVE SPRINGS

Multi Turn, Inch

Used for low to medium force applications with greater travel compared to single-turn springs. Utilizes nearly half the space as helical compression springs while producing the same force.

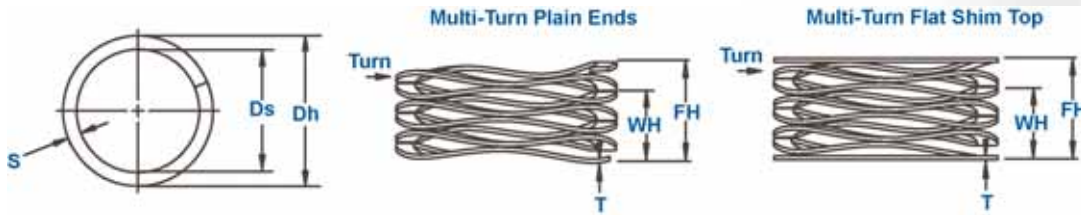

WAVE SPRING NO.	PILOTS & OPERATES IN HOUSING DIAMETER			SHAFT DIAMETER CLEARANCE Ds	LOAD (lbs.)	WORK HEIGHT	FREE HEIGHT Ref.	NUMBER OF WAVES	NUMBER OF TURNS	THICKNESS	SECTION	SPRING RATE Ref. lb/in.
	Dh DEC	Dh FRAC	Dh mm			WH	FH			T	s	
WSL-25 A*	.250	1/4	6.4	.150	2	.033	.075	2.5	3	.006	.024	48
WSL-25 B*	.250	1/4	6.4	.150	2	.050	.100	2.5	4	.006	.024	40
WSL-25 C*	.250	1/4	6.4	.150	2	.060	.125	2.5	5	.006	.024	31
WSL-25 D*	.250	1/4	6.4	.150	2	.075	.150	2.5	6	.006	.024	27
WSL-25 E*	.250	1/4	6.4	.150	2	.085	.175	2.5	7	.006	.024	22
WSL-25 F*	.250	1/4	6.4	.150	2	.095	.200	2.5	8	.006	.024	19
WSL-25 G*	.250	1/4	6.4	.150	2	.120	.225	2.5	9	.006	.024	19
WSL-25 H*	.250	1/4	6.4	.150	2	.140	.275	2.5	11	.006	.024	15
WSL-25 I*	.250	1/4	6.4	.150	2	.170	.325	2.5	13	.006	.024	13
WSM-25 A*	.250	1/4	6.4	.150	5	.037	.075	2.5	3	.008	.024	132
WSM-25 B*	.250	1/4	6.4	.150	5	.048	.100	2.5	4	.008	.024	96
WSM-25 C*	.250	1/4	6.4	.150	5	.065	.125	2.5	5	.008	.024	83
WSM-25 D*	.250	1/4	6.4	.150	5	.075	.150	2.5	6	.008	.024	67
WSM-25 E*	.250	1/4	6.4	.150	5	.090	.175	2.5	7	.008	.024	59
WSM-25 F*	.250	1/4	6.4	.150	5	.100	.200	2.5	8	.008	.024	50
WSM-25 G*	.250	1/4	6.4	.150	5	.120	.225	2.5	9	.008	.024	48
WSM-25 H*	.250	1/4	6.4	.150	5	.148	.275	2.5	11	.008	.024	39
WSM-25 I*	.250	1/4	6.4	.150	5	.175	.325	2.5	13	.008	.024	33
WSL-31 A	.312	5/16	7.9	.200	3	.070	.114	2.5	3	.008	.032	68
WSL-31 B	.312	5/16	7.9	.200	3	.096	.152	2.5	4	.008	.032	54
WSL-31 C	.312	5/16	7.9	.200	3	.118	.190	2.5	5	.008	.032	42
WSL-31 D	.312	5/16	7.9	.200	3	.145	.228	2.5	6	.008	.032	36
WSL-31 E	.312	5/16	7.9	.200	3	.165	.266	2.5	7	.008	.032	30
WSL-31 F	.312	5/16	7.9	.200	3	.195	.304	2.5	8	.008	.032	28
WSL-31 G	.312	5/16	7.9	.200	3	.215	.342	2.5	9	.008	.032	24
WSL-31 H	.312	5/16	7.9	.200	3	.262	.418	2.5	11	.008	.032	19
WSL-31 I	.312	5/16	7.9	.200	3	.309	.494	2.5	13	.008	.032	16
WSM-31 A	.312	5/16	7.9	.200	6	.072	.114	2.5	3	.010	.032	143
WSM-31 B	.312	5/16	7.9	.200	6	.096	.152	2.5	4	.010	.032	107
WSM-31 C	.312	5/16	7.9	.200	6	.123	.190	2.5	5	.010	.032	90
WSM-31 D	.312	5/16	7.9	.200	6	.144	.228	2.5	6	.010	.032	71
WSM-31 E	.312	5/16	7.9	.200	6	.176	.266	2.5	7	.010	.032	67
WSM-31 F	.312	5/16	7.9	.200	6	.197	.304	2.5	8	.010	.032	56
WSM-31 G	.312	5/16	7.9	.200	6	.227	.342	2.5	9	.010	.032	52
WSM-31 H	.312	5/16	7.9	.200	6	.278	.418	2.5	11	.010	.032	43
WSM-31 I	.312	5/16	7.9	.200	6	.336	.494	2.5	13	.010	.032	38

*Not available with shim ends

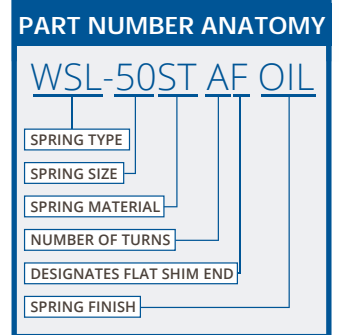

Part numbers shown in the table reflect multi-turn wave springs with plain ends.

The letters shown after the part numbers represent the number of turns.

When ordering, parts should be presented with the part number, followed by the material, and then the number of turns (i.e. WSL-37ST A, WSM-50ST B, WSR-75ST C, etc.)

For flat shim top wave springs, add an 'F' to the end of the part number (i.e. WSL-37ST AF, WSM-50ST BF, WSR-75ST CF, etc.)

Standard Material Codes:

ST = carbon steel.

SQ = 17-7 PH/C stainless steel.

Special alloys available upon request.

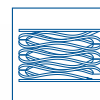

WSL, WSM, WSR WAVE SPRINGS

Multi Turn, Inch

Used for low to medium force applications with greater travel compared to single-turn springs. Utilizes nearly half the space as helical compression springs while producing the same force.

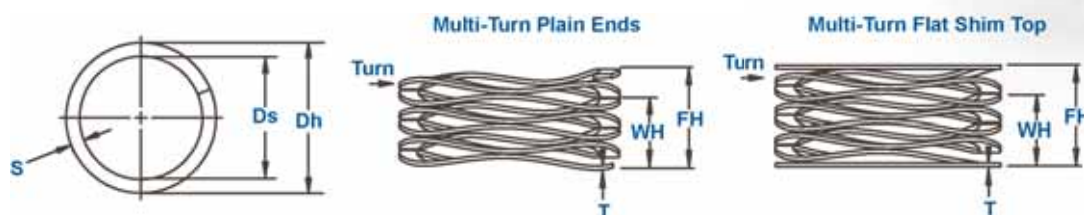

WAVE SPRING NO.	PILOTS & OPERATES IN HOUSING DIAMETER			SHAFT DIAMETER CLEARANCE Ds	LOAD (lbs.)	WORK HEIGHT	FREE HEIGHT Ref.	NUMBER OF WAVES	NUMBER OF TURNS	THICKNESS	SECTION	SPRING RATE Ref. lb/in.
	Dh DEC	Dh FRAC	Dh mm			WH	FH			T	s	
WSL-37 A	.375	3/8	9.5	.250	4	.062	.150	2.5	3	.008	.032	45
WSL-37 B	.375	3/8	9.5	.250	4	.098	.200	2.5	4	.008	.032	39
WSL-37 C	.375	3/8	9.5	.250	4	.108	.250	2.5	5	.008	.032	28
WSL-37 D	.375	3/8	9.5	.250	4	.135	.300	2.5	6	.008	.032	24
WSL-37 E	.375	3/8	9.5	.250	4	.150	.350	2.5	7	.008	.032	20
WSL-37 F	.375	3/8	9.5	.250	4	.184	.400	2.5	8	.008	.032	19
WSL-37 G	.375	3/8	9.5	.250	4	.195	.450	2.5	9	.008	.032	16
WSL-37 H	.375	3/8	9.5	.250	4	.228	.500	2.5	10	.008	.032	15
WSL-37 I	.375	3/8	9.5	.250	4	.240	.550	2.5	11	.008	.032	13
WSM-37 A	.375	3/8	9.5	.250	7	.081	.150	2.5	3	.011	.032	101
WSM-37 B	.375	3/8	9.5	.250	7	.119	.200	2.5	4	.011	.032	86
WSM-37 C	.375	3/8	9.5	.250	7	.145	.250	2.5	5	.011	.032	67
WSM-37 D	.375	3/8	9.5	.250	7	.180	.300	2.5	6	.011	.032	58
WSM-37 E	.375	3/8	9.5	.250	7	.202	.350	2.5	7	.011	.032	47
WSM-37 F	.375	3/8	9.5	.250	7	.240	.400	2.5	8	.011	.032	44
WSM-37 G	.375	3/8	9.5	.250	7	.262	.450	2.5	9	.011	.032	37
WSM-37 H	.375	3/8	9.5	.250	7	.298	.500	2.5	10	.011	.032	35
WSM-37 I	.375	3/8	9.5	.250	7	.327	.550	2.5	11	.011	.032	31
WSL-43 A	.437	7/16	11.1	.281	4	.063	.165	2.5	3	.008	.040	39
WSL-43 B	.437	7/16	11.1	.281	4	.093	.220	2.5	4	.008	.040	31
WSL-43 C	.437	7/16	11.1	.281	4	.109	.275	2.5	5	.008	.040	24
WSL-43 D	.437	7/16	11.1	.281	4	.143	.330	2.5	6	.008	.040	21
WSL-43 E	.437	7/16	11.1	.281	4	.160	.385	2.5	7	.008	.040	18
WSL-43 F	.437	7/16	11.1	.281	4	.195	.440	2.5	8	.008	.040	16
WSL-43 G	.437	7/16	11.1	.281	4	.210	.495	2.5	9	.008	.040	14
WSL-43 H	.437	7/16	11.1	.281	4	.240	.550	2.5	10	.008	.040	13
WSL-43 I	.437	7/16	11.1	.281	4	.260	.605	2.5	11	.008	.040	12
WSM-43 A	.437	7/16	11.1	.281	8	.082	.165	2.5	3	.011	.046	96
WSM-43 B	.437	7/16	11.1	.281	8	.115	.220	2.5	4	.011	.046	76
WSM-43 C	.437	7/16	11.1	.281	8	.142	.275	2.5	5	.011	.046	60
WSM-43 D	.437	7/16	11.1	.281	8	.179	.330	2.5	6	.011	.046	53
WSM-43 E	.437	7/16	11.1	.281	8	.198	.385	2.5	7	.011	.046	43
WSM-43 F	.437	7/16	11.1	.281	8	.231	.440	2.5	8	.011	.046	38
WSM-43 G	.437	7/16	11.1	.281	8	.255	.495	2.5	9	.011	.046	33
WSM-43 H	.437	7/16	11.1	.281	8	.290	.550	2.5	10	.011	.046	31
WSM-43 I	.437	7/16	11.1	.281	8	.319	.605	2.5	11	.011	.046	28

PART NUMBER ANATOMY

WSL-50ST AF OIL

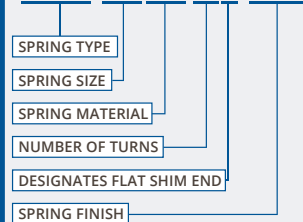

Part numbers shown in the table reflect multi-turn wave springs with plain ends.

The letters shown after the part numbers represent the number of turns.

When ordering, parts should be presented with the part number, followed by the material, and then the number of turns (i.e. WSL-37ST A, WSM-50ST B, WSR-75ST C, etc.)

For flat shim top wave springs, add an 'F' to the end of the part number (i.e. WSL-37ST AF, WSM-50ST BF, WSR-75ST CF, etc.)

Standard Material Codes:

- ST = carbon steel.
- SQ = 17-7 PH/C stainless steel.
- Special alloys available upon request.

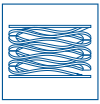

WSL, WSM, WSR WAVE SPRINGS

Multi Turn, Inch

Used for low to medium force applications with greater travel compared to single-turn springs. Utilizes nearly half the space as helical compression springs while producing the same force.

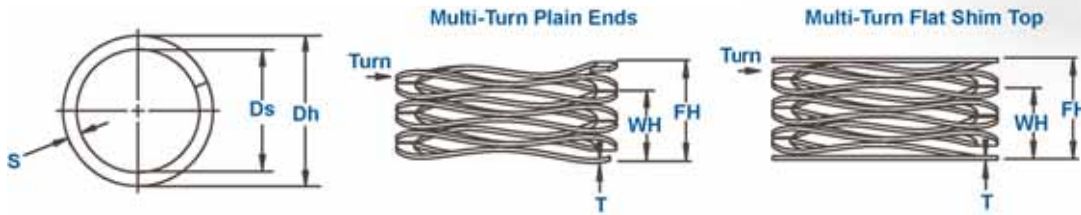

WAVE SPRING NO.	PILOTS & OPERATES IN HOUSING DIAMETER			SHAFT DIAMETER CLEARANCE Ds	LOAD (lbs.)	WORK HEIGHT	FREE HEIGHT Ref.	NUMBER OF WAVES	NUMBER OF TURNS	THICKNESS	SECTION	SPRING RATE Ref. lb/in.
	Dh DEC	Dh FRAC	Dh mm			WH	FH			T	s	
WSL-50 A	.500	1/2	12.7	.312	5	.062	.180	2.5	3	.008	.056	42
WSL-50 B	.500	1/2	12.7	.312	5	.090	.240	2.5	4	.008	.056	33
WSL-50 C	.500	1/2	12.7	.312	5	.107	.300	2.5	5	.008	.056	26
WSL-50 D	.500	1/2	12.7	.312	5	.136	.360	2.5	6	.008	.056	22
WSL-50 E	.500	1/2	12.7	.312	5	.150	.420	2.5	7	.008	.056	19
WSL-50 F	.500	1/2	12.7	.312	5	.180	.480	2.5	8	.008	.056	17
WSL-50 G	.500	1/2	12.7	.312	5	.195	.540	2.5	9	.008	.056	14
WSL-50 H	.500	1/2	12.7	.312	5	.220	.600	2.5	10	.008	.056	13
WSL-50 I	.500	1/2	12.7	.312	5	.240	.660	2.5	11	.008	.056	12
WSM-50 A	.500	1/2	12.7	.312	10	.065	.180	2.5	3	.010	.058	87
WSM-50 B	.500	1/2	12.7	.312	10	.092	.240	2.5	4	.010	.058	68
WSM-50 C	.500	1/2	12.7	.312	10	.114	.300	2.5	5	.010	.058	54
WSM-50 D	.500	1/2	12.7	.312	10	.147	.360	2.5	6	.010	.058	47
WSM-50 E	.500	1/2	12.7	.312	10	.162	.420	2.5	7	.010	.058	39
WSM-50 F	.500	1/2	12.7	.312	10	.196	.480	2.5	8	.010	.058	35
WSM-50 G	.500	1/2	12.7	.312	10	.207	.540	2.5	9	.010	.058	30
WSM-50 H	.500	1/2	12.7	.312	10	.246	.600	2.5	10	.010	.058	28
WSM-50 I	.500	1/2	12.7	.312	10	.264	.660	2.5	11	.010	.058	25
WSL-56 A	.562	9/16	14.3	.375	5	.080	.195	2.5	3	.009	.058	43
WSL-56 B	.562	9/16	14.3	.375	5	.125	.260	2.5	4	.009	.058	37
WSL-56 C	.562	9/16	14.3	.375	5	.135	.325	2.5	5	.009	.058	26
WSL-56 D	.562	9/16	14.3	.375	5	.180	.390	2.5	6	.009	.058	24
WSL-56 E	.562	9/16	14.3	.375	5	.190	.455	2.5	7	.009	.058	19
WSL-56 F	.562	9/16	14.3	.375	5	.230	.520	2.5	8	.009	.058	17
WSL-56 G	.562	9/16	14.3	.375	5	.260	.585	2.5	9	.009	.058	15
WSL-56 H	.562	9/16	14.3	.375	5	.285	.650	2.5	10	.009	.058	14
WSL-56 I	.562	9/16	14.3	.375	5	.315	.715	2.5	11	.009	.058	13
WSM-56 A	.562	9/16	14.3	.375	11	.086	.195	2.5	3	.012	.060	101
WSM-56 B	.562	9/16	14.3	.375	11	.123	.260	2.5	4	.012	.060	80
WSM-56 C	.562	9/16	14.3	.375	11	.145	.325	2.5	5	.012	.060	61
WSM-56 D	.562	9/16	14.3	.375	11	.187	.390	2.5	6	.012	.060	54
WSM-56 E	.562	9/16	14.3	.375	11	.209	.455	2.5	7	.012	.060	45
WSM-56 F	.562	9/16	14.3	.375	11	.253	.520	2.5	8	.012	.060	41
WSM-56 G	.562	9/16	14.3	.375	11	.273	.585	2.5	9	.012	.060	35
WSM-56 H	.562	9/16	14.3	.375	11	.318	.650	2.5	10	.012	.060	33
WSM-56 I	.562	9/16	14.3	.375	11	.343	.715	2.5	11	.012	.060	30

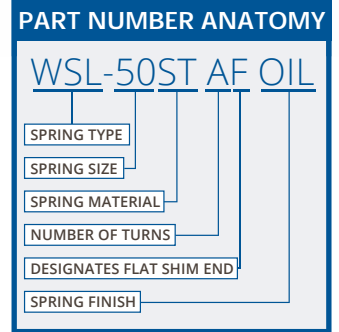

Part numbers shown in the table reflect multi-turn wave springs with plain ends.

The letters shown after the part numbers represent the number of turns.

When ordering, parts should be presented with the part number, followed by the material, and then the number of turns (i.e. WSL-37ST A, WSM-50ST B, WSR-75ST C, etc.)

For flat shim top wave springs, add an 'F' to the end of the part number (i.e. WSL-37ST AF, WSM-50ST BF, WSR-75ST CF, etc.)

Standard Material Codes:
 ST = carbon steel.
 SQ = 17-7 PH/C stainless steel.
 Special alloys available upon request.

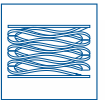

WSL, WSM, WSR WAVE SPRINGS

Multi Turn, Inch

Used for low to medium force applications with greater travel compared to single-turn springs. Utilizes nearly half the space as helical compression springs while producing the same force.

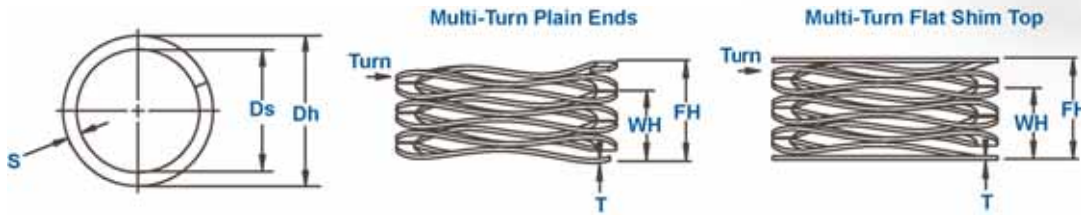

WAVE SPRING NO.	PILOTS & OPERATES IN HOUSING DIAMETER			SHAFT DIAMETER CLEARANCE Ds	LOAD (lbs.)	WORK HEIGHT	FREE HEIGHT Ref.	NUMBER OF WAVES	NUMBER OF TURNS	THICKNESS	SECTION	SPRING RATE Ref. lb/in.
	Dh DEC	Dh FRAC	Dh mm			WH	FH			T	s	
WSL-62 A	.625	5/8	15.9	.450	6	.055	.180	2.5	3	.010	.058	48
WSL-62 B	.625	5/8	15.9	.450	6	.068	.240	2.5	4	.010	.058	35
WSL-62 C	.625	5/8	15.9	.450	6	.085	.300	2.5	5	.010	.058	28
WSL-62 D	.625	5/8	15.9	.450	6	.106	.360	2.5	6	.010	.058	24
WSL-62 E	.625	5/8	15.9	.450	6	.128	.420	2.5	7	.010	.058	21
WSL-62 F	.625	5/8	15.9	.450	6	.165	.540	2.5	9	.010	.058	16
WSL-62 G	.625	5/8	15.9	.450	6	.202	.660	2.5	11	.010	.058	13
WSL-62 H	.625	5/8	15.9	.450	6	.238	.780	2.5	13	.010	.058	11
WSM-62 A	.625	5/8	15.9	.450	12	.104	.180	3.5	3	.010	.058	158
WSM-62 B	.625	5/8	15.9	.450	12	.130	.240	3.5	4	.010	.058	109
WSM-62 C	.625	5/8	15.9	.450	12	.175	.300	3.5	5	.010	.058	96
WSM-62 D	.625	5/8	15.9	.450	12	.206	.360	3.5	6	.010	.058	78
WSM-62 E	.625	5/8	15.9	.450	12	.246	.420	3.5	7	.010	.058	69
WSM-62 F	.625	5/8	15.9	.450	12	.317	.540	3.5	9	.010	.058	54
WSM-62 G	.625	5/8	15.9	.450	12	.386	.660	3.5	11	.010	.058	44
WSM-62 H	.625	5/8	15.9	.450	12	.454	.780	3.5	13	.010	.058	37
WSL-75 A	.750	3/4	19.0	.550	7	.142	.250	3.5	3	.008	.071	65
WSL-75 B	.750	3/4	19.0	.550	7	.187	.333	3.5	4	.008	.071	48
WSL-75 C	.750	3/4	19.0	.550	7	.246	.417	3.5	5	.008	.071	41
WSL-75 D	.750	3/4	19.0	.550	7	.285	.500	3.5	6	.008	.071	33
WSL-75 E	.750	3/4	19.0	.550	7	.348	.583	3.5	7	.008	.071	30
WSL-75 F	.750	3/4	19.0	.550	7	.446	.750	3.5	9	.008	.071	23
WSL-75 G	.750	3/4	19.0	.550	7	.580	1.000	3.5	12	.008	.071	17
WSM-75 A	.750	3/4	19.0	.550	13	.159	.250	3.5	3	.010	.078	143
WSM-75 B	.750	3/4	19.0	.550	13	.203	.333	3.5	4	.010	.078	100
WSM-75 C	.750	3/4	19.0	.550	13	.270	.417	3.5	5	.010	.078	88
WSM-75 D	.750	3/4	19.0	.550	13	.314	.500	3.5	6	.010	.078	70
WSM-75 E	.750	3/4	19.0	.550	13	.381	.583	3.5	7	.010	.078	64
WSM-75 F	.750	3/4	19.0	.550	13	.489	.750	3.5	9	.010	.078	50
WSM-75 G	.750	3/4	19.0	.550	13	.649	1.000	3.5	12	.010	.078	37
WSR-75 A	.750	3/4	19.0	.550	22	.169	.250	3.5	3	.013	.079	272
WSR-75 B	.750	3/4	19.0	.550	22	.215	.333	3.5	4	.013	.079	186
WSR-75 C	.750	3/4	19.0	.550	22	.291	.417	3.5	5	.013	.079	175
WSR-75 D	.750	3/4	19.0	.550	22	.335	.500	3.5	6	.013	.079	133
WSR-75 E	.750	3/4	19.0	.550	22	.405	.583	3.5	7	.013	.079	124
WSR-75 F	.750	3/4	19.0	.550	22	.526	.750	3.5	9	.013	.079	98
WSR-75 G	.750	3/4	19.0	.550	22	.699	1.000	3.5	12	.013	.079	73

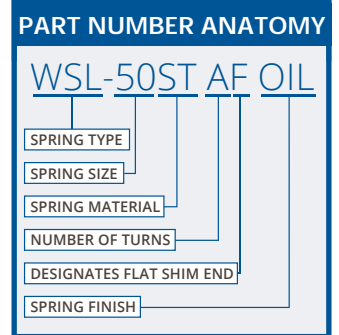

Part numbers shown in the table reflect multi-turn wave springs with plain ends.

The letters shown after the part numbers represent the number of turns.

When ordering, parts should be presented with the part number, followed by the material, and then the number of turns (i.e. WSL-37ST A, WSM-50ST B, WSR-75ST C, etc.)

For flat shim top wave springs, add an 'F' to the end of the part number (i.e. WSL-37ST AF, WSM-50ST BF, WSR-75ST CF, etc.)

Standard Material Codes:
 ST = carbon steel.
 SQ = 17-7 PH/C stainless steel.
 Special alloys available upon request.

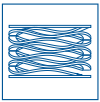

WSL, WSM, WSR WAVE SPRINGS

Multi Turn, Inch

Used for low to medium force applications with greater travel compared to single-turn springs. Utilizes nearly half the space as helical compression springs while producing the same force.

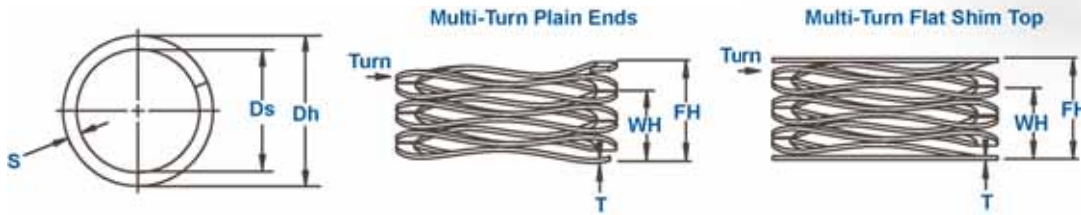

WAVE SPRING NO.	PILOTS & OPERATES IN HOUSING DIAMETER			SHAFT DIAMETER CLEARANCE Ds	LOAD (lbs.)	WORK HEIGHT		NUMBER OF WAVES	NUMBER OF TURNS	THICKNESS T	SECTION s	SPRING RATE Ref. lb/in.
	Dh DEC	Dh FRAC	Dh mm			WH	FH					
WSL-87 A	.875	7/8	22.2	.600	12	.117	.250	3.5	3	.010	.086	90
WSL-87 B	.875	7/8	22.2	.600	12	.158	.333	3.5	4	.010	.086	69
WSL-87 C	.875	7/8	22.2	.600	12	.207	.417	3.5	5	.010	.086	57
WSL-87 D	.875	7/8	22.2	.600	12	.242	.500	3.5	6	.010	.086	47
WSL-87 E	.875	7/8	22.2	.600	12	.287	.583	3.5	7	.010	.086	41
WSL-87 F	.875	7/8	22.2	.600	12	.378	.750	3.5	9	.010	.086	32
WSL-87 G	.875	7/8	22.2	.600	12	.498	1.000	3.5	12	.010	.086	24
WSM-87 A	.875	7/8	22.2	.600	18	.124	.250	3.5	3	.012	.094	148
WSM-87 B	.875	7/8	22.2	.600	18	.164	.333	3.5	4	.012	.094	108
WSM-87 C	.875	7/8	22.2	.600	18	.214	.417	3.5	5	.012	.094	89
WSM-87 D	.875	7/8	22.2	.600	18	.252	.500	3.5	6	.012	.094	76
WSM-87 E	.875	7/8	22.2	.600	18	.296	.583	3.5	7	.012	.094	66
WSM-87 F	.875	7/8	22.2	.600	18	.385	.750	3.5	9	.012	.094	50
WSM-87 G	.875	7/8	22.2	.600	18	.509	1.000	3.5	12	.012	.094	38
WSR-87 A	.875	7/8	22.2	.600	25	.166	.250	3.5	3	.015	.094	298
WSR-87 B	.875	7/8	22.2	.600	25	.214	.333	3.5	4	.015	.094	210
WSR-87 C	.875	7/8	22.2	.600	25	.278	.417	3.5	5	.015	.094	180
WSR-87 D	.875	7/8	22.2	.600	25	.327	.500	3.5	6	.015	.094	145
WSR-87 E	.875	7/8	22.2	.600	25	.395	.583	3.5	7	.015	.094	133
WSR-87 F	.875	7/8	22.2	.600	25	.510	.750	3.5	9	.015	.094	104
WSR-87 G	.875	7/8	22.2	.600	25	.670	1.000	3.5	12	.015	.094	78
WSL-100 A	1.000	1	25.4	.730	12	.084	.250	3.5	3	.010	.086	72
WSL-100 B	1.000	1	25.4	.730	12	.108	.333	3.5	4	.010	.086	53
WSL-100 C	1.000	1	25.4	.730	12	.145	.417	3.5	5	.010	.086	44
WSL-100 D	1.000	1	25.4	.730	12	.165	.500	3.5	6	.010	.086	36
WSL-100 E	1.000	1	25.4	.730	12	.201	.583	3.5	7	.010	.086	31
WSL-100 F	1.000	1	25.4	.730	12	.258	.750	3.5	9	.010	.086	24
WSL-100 G	1.000	1	25.4	.730	12	.342	1.000	3.5	12	.010	.086	18
WSL-100 H	1.000	1	25.4	.730	12	.445	1.250	3.5	15	.010	.086	15
WSL-100 I	1.000	1	25.4	.730	12	.519	1.500	3.5	18	.010	.086	12
WSL-100 J	1.000	1	25.4	.730	12	.633	1.750	3.5	21	.010	.086	11
WSL-100 K	1.000	1	25.4	.730	12	.710	2.000	3.5	24	.010	.086	9
WSM-100 A	1.000	1	25.4	.730	18	.087	.250	3.5	3	.012	.094	110
WSM-100 B	1.000	1	25.4	.730	18	.113	.333	3.5	4	.012	.094	82
WSM-100 C	1.000	1	25.4	.730	18	.148	.417	3.5	5	.012	.094	67
WSM-100 D	1.000	1	25.4	.730	18	.175	.500	3.5	6	.012	.094	55
WSM-100 E	1.000	1	25.4	.730	18	.212	.583	3.5	7	.012	.094	49

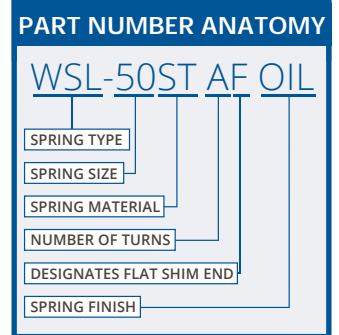

Part numbers shown in the table reflect multi-turn wave springs with plain ends.

The letters shown after the part numbers represent the number of turns.

When ordering, parts should be presented with the part number, followed by the material, and then the number of turns (i.e. WSL-37ST A, WSM-50ST B, WSR-75ST C, etc.)

For flat shim top wave springs, add an 'F' to the end of the part number (i.e. WSL-37ST AF, WSM-50ST BF, WSR-75ST CF, etc.)

Standard Material Codes:
 ST = carbon steel.
 SQ = 17-7 PH/C stainless steel.
 Special alloys available upon request.

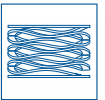

WSL, WSM, WSR WAVE SPRINGS

Multi Turn, Inch

Used for low to medium force applications with greater travel compared to single-turn springs. Utilizes nearly half the space as helical compression springs while producing the same force.

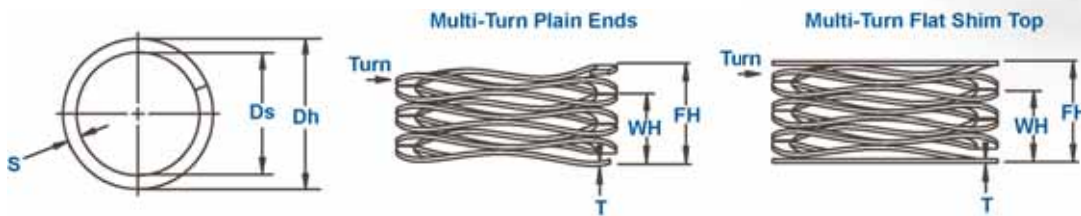

WAVE SPRING NO.	PILOTS & OPERATES IN HOUSING DIAMETER			SHAFT DIAMETER CLEARANCE Ds	LOAD (lbs.)	WORK HEIGHT WH	FREE HEIGHT Ref. FH	NUMBER OF WAVES	NUMBER OF TURNS	THICKNESS T	SECTION s	SPRING RATE Ref. lb/in.
	Dh DEC	Dh FRAC	Dh mm									
WSM-100 F	1.000	1	25.4	.730	18	.276	.750	3.5	9	.012	.094	38
WSM-100 G	1.000	1	25.4	.730	18	.360	1.000	3.5	12	.012	.094	28
WSM-100 H	1.000	1	25.4	.730	18	.452	1.250	3.5	15	.012	.094	23
WSM-100 I	1.000	1	25.4	.730	18	.549	1.500	3.5	18	.012	.094	19
WSM-100 J	1.000	1	25.4	.730	18	.650	1.750	3.5	21	.012	.094	16
WSM-100 K	1.000	1	25.4	.730	18	.720	2.000	3.5	24	.012	.094	14
WSR-100 A	1.000	1	25.4	.730	25	.131	.250	3.5	3	.015	.094	210
WSR-100 B	1.000	1	25.4	.730	25	.174	.333	3.5	4	.015	.094	157
WSR-100 C	1.000	1	25.4	.730	25	.227	.417	3.5	5	.015	.094	132
WSR-100 D	1.000	1	25.4	.730	25	.266	.500	3.5	6	.015	.094	107
WSR-100 E	1.000	1	25.4	.730	25	.319	.583	3.5	7	.015	.094	95
WSR-100 F	1.000	1	25.4	.730	25	.406	.750	3.5	9	.015	.094	73
WSR-100 G	1.000	1	25.4	.730	25	.541	1.000	3.5	12	.015	.094	54
WSR-100 H	1.000	1	25.4	.730	25	.688	1.250	3.5	15	.015	.094	45
WSR-100 I	1.000	1	25.4	.730	25	.813	1.500	3.5	18	.015	.094	36
WSR-100 J	1.000	1	25.4	.730	25	.957	1.750	3.5	21	.015	.094	32
WSR-100 K	1.000	1	25.4	.730	25	1.083	2.000	3.5	24	.015	.094	27
WSL-112 A	1.125	1-1/8	28.6	.850	12	.146	.300	3.5	3	.012	.094	78
WSL-112 B	1.125	1-1/8	28.6	.850	12	.186	.400	3.5	4	.012	.094	56
WSL-112 C	1.125	1-1/8	28.6	.850	12	.250	.500	3.5	5	.012	.094	48
WSL-112 D	1.125	1-1/8	28.6	.850	12	.295	.600	3.5	6	.012	.094	39
WSL-112 E	1.125	1-1/8	28.6	.850	12	.344	.700	3.5	7	.012	.094	34
WSL-112 F	1.125	1-1/8	28.6	.850	12	.392	.800	3.5	8	.012	.094	29
WSL-112 G	1.125	1-1/8	28.6	.850	12	.488	1.000	3.5	10	.012	.094	23
WSL-112 H	1.125	1-1/8	28.6	.850	12	.659	1.300	3.5	13	.012	.094	19
WSL-112 I	1.125	1-1/8	28.6	.850	12	.807	1.600	3.5	16	.012	.094	15
WSL-112 J	1.125	1-1/8	28.6	.850	12	1.017	2.000	3.5	20	.012	.094	12
WSM-112 A	1.125	1-1/8	28.6	.850	20	.160	.300	3.5	3	.015	.094	143
WSM-112 B	1.125	1-1/8	28.6	.850	20	.202	.400	3.5	4	.015	.094	101
WSM-112 C	1.125	1-1/8	28.6	.850	20	.270	.500	3.5	5	.015	.094	87
WSM-112 D	1.125	1-1/8	28.6	.850	20	.318	.600	3.5	6	.015	.094	71
WSM-112 E	1.125	1-1/8	28.6	.850	20	.381	.700	3.5	7	.015	.094	63
WSM-112 F	1.125	1-1/8	28.6	.850	20	.427	.800	3.5	8	.015	.094	54
WSM-112 G	1.125	1-1/8	28.6	.850	20	.536	1.000	3.5	10	.015	.094	43
WSM-112 H	1.125	1-1/8	28.6	.850	20	.708	1.300	3.5	13	.015	.094	34
WSM-112 I	1.125	1-1/8	28.6	.850	20	.861	1.600	3.5	16	.015	.094	27
WSM-112 J	1.125	1-1/8	28.6	.850	20	1.088	2.000	3.5	20	.015	.094	22

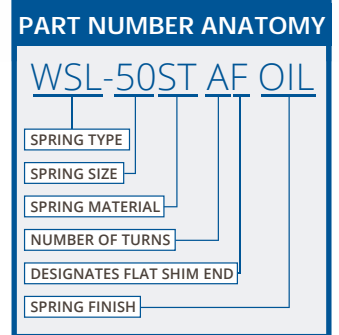

Part numbers shown in the table reflect multi-turn wave springs with plain ends.

The letters shown after the part numbers represent the number of turns.

When ordering, parts should be presented with the part number, followed by the material, and then the number of turns (i.e. WSL-37ST A, WSM-50ST B, WSR-75ST C, etc.)

For flat shim top wave springs, add an 'F' to the end of the part number (i.e. WSL-37ST AF, WSM-50ST BF, WSR-75ST CF, etc.)

Standard Material Codes:
 ST = carbon steel.
 SQ = 17-7 PH/C stainless steel.
 Special alloys available upon request.

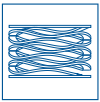

WSL, WSM, WSR WAVE SPRINGS

Multi Turn, Inch

Used for low to medium force applications with greater travel compared to single-turn springs. Utilizes nearly half the space as helical compression springs while producing the same force.

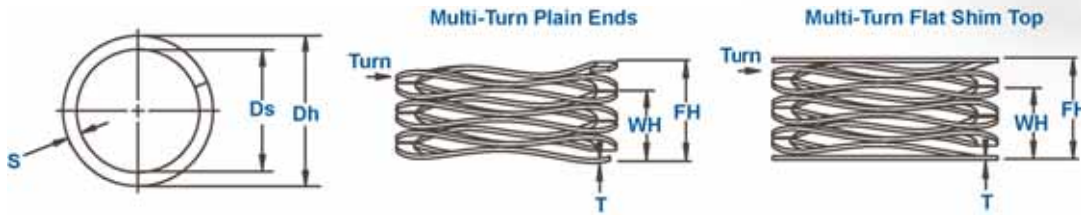

WAVE SPRING NO.	PILOTS & OPERATES IN HOUSING DIAMETER			SHAFT DIAMETER CLEARANCE	LOAD (lbs.)	WORK HEIGHT	FREE HEIGHT Ref.	NUMBER OF WAVES	NUMBER OF TURNS	THICKNESS	SECTION	SPRING RATE Ref.
	Dh DEC	Dh FRAC	Dh mm			Ds	WH			FH	T	
WSR-112 A	1.125	1-1/8	28.6	.850	30	.178	.300	3.5	3	.018	.094	246
WSR-112 B	1.125	1-1/8	28.6	.850	30	.229	.400	3.5	4	.018	.094	175
WSR-112 C	1.125	1-1/8	28.6	.850	30	.303	.500	3.5	5	.018	.094	152
WSR-112 D	1.125	1-1/8	28.6	.850	30	.350	.600	3.5	6	.018	.094	120
WSR-112 E	1.125	1-1/8	28.6	.850	30	.421	.700	3.5	7	.018	.094	108
WSR-112 F	1.125	1-1/8	28.6	.850	30	.470	.800	3.5	8	.018	.094	91
WSR-112 G	1.125	1-1/8	28.6	.850	30	.593	1.000	3.5	10	.018	.094	74
WSR-112 H	1.125	1-1/8	28.6	.850	30	.787	1.300	3.5	13	.018	.094	58
WSR-112 I	1.125	1-1/8	28.6	.850	30	.956	1.600	3.5	16	.018	.094	47
WSR-112 J	1.125	1-1/8	28.6	.850	30	1.202	2.000	3.5	20	.018	.094	38
WSL-125 A	1.250	1-1/4	31.7	1.000	12	.084	.300	3.5	3	.012	.094	56
WSL-125 B	1.250	1-1/4	31.7	1.000	12	.113	.400	3.5	4	.012	.094	42
WSL-125 C	1.250	1-1/4	31.7	1.000	12	.149	.500	3.5	5	.012	.094	34
WSL-125 D	1.250	1-1/4	31.7	1.000	12	.172	.600	3.5	6	.012	.094	28
WSL-125 E	1.250	1-1/4	31.7	1.000	12	.207	.700	3.5	7	.012	.094	24
WSL-125 F	1.250	1-1/4	31.7	1.000	12	.227	.800	3.5	8	.012	.094	21
WSL-125 G	1.250	1-1/4	31.7	1.000	12	.301	1.000	3.5	10	.012	.094	17
WSL-125 H	1.250	1-1/4	31.7	1.000	12	.395	1.300	3.5	13	.012	.094	13
WSL-125 I	1.250	1-1/4	31.7	1.000	12	.467	1.600	3.5	16	.012	.094	11
WSL-125 J	1.250	1-1/4	31.7	1.000	12	.591	2.000	3.5	20	.012	.094	9
WSM-125 A	1.250	1-1/4	31.7	1.000	20	.124	.300	3.5	3	.015	.094	114
WSM-125 B	1.250	1-1/4	31.7	1.000	20	.165	.400	3.5	4	.015	.094	85
WSM-125 C	1.250	1-1/4	31.7	1.000	20	.215	.500	3.5	5	.015	.094	70
WSM-125 D	1.250	1-1/4	31.7	1.000	20	.253	.600	3.5	6	.015	.094	58
WSM-125 E	1.250	1-1/4	31.7	1.000	20	.303	.700	3.5	7	.015	.094	50
WSM-125 F	1.250	1-1/4	31.7	1.000	20	.341	.800	3.5	8	.015	.094	44
WSM-125 G	1.250	1-1/4	31.7	1.000	20	.427	1.000	3.5	10	.015	.094	35
WSM-125 H	1.250	1-1/4	31.7	1.000	20	.577	1.300	3.5	13	.015	.094	28
WSM-125 I	1.250	1-1/4	31.7	1.000	20	.692	1.600	3.5	16	.015	.094	22
WSM-125 J	1.250	1-1/4	31.7	1.000	20	.866	2.000	3.5	20	.015	.094	18
WSR-125 A	1.250	1-1/4	31.7	1.000	30	.158	.300	3.5	3	.019	.094	210
WSR-125 B	1.250	1-1/4	31.7	1.000	30	.210	.400	3.5	4	.019	.094	158
WSR-125 C	1.250	1-1/4	31.7	1.000	30	.272	.500	3.5	5	.019	.094	132
WSR-125 D	1.250	1-1/4	31.7	1.000	30	.320	.600	3.5	6	.019	.094	107
WSR-125 E	1.250	1-1/4	31.7	1.000	30	.384	.700	3.5	7	.019	.094	95
WSR-125 F	1.250	1-1/4	31.7	1.000	30	.433	.800	3.5	8	.019	.094	82
WSR-125 G	1.250	1-1/4	31.7	1.000	30	.538	1.000	3.5	10	.019	.094	65
WSR-125 H	1.250	1-1/4	31.7	1.000	30	.717	1.300	3.5	13	.019	.094	51
WSR-125 I	1.250	1-1/4	31.7	1.000	30	.878	1.600	3.5	16	.019	.094	42
WSR-125 J	1.250	1-1/4	31.7	1.000	30	1.103	2.000	3.5	20	.019	.094	33

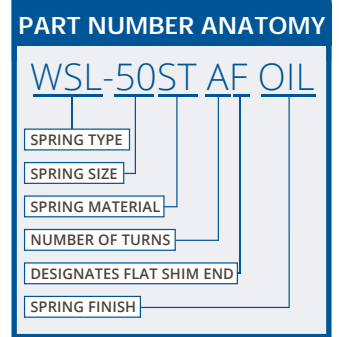

Part numbers shown in the table reflect multi-turn wave springs with plain ends.

The letters shown after the part numbers represent the number of turns.

When ordering, parts should be presented with the part number, followed by the material, and then the number of turns (i.e. WSL-37ST A, WSM-50ST B, WSR-75ST C, etc.)

For flat shim top wave springs, add an 'F' to the end of the part number (i.e. WSL-37ST AF, WSM-50ST BF, WSR-75ST CF, etc.)

Standard Material Codes:

ST = carbon steel.
 SQ = 17-7 PH/C stainless steel.
 Special alloys available upon request.

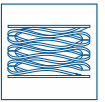

WSL, WSM, WSR WAVE SPRINGS

Multi Turn, Inch

Used for low to medium force applications with greater travel compared to single-turn springs. Utilizes nearly half the space as helical compression springs while producing the same force.

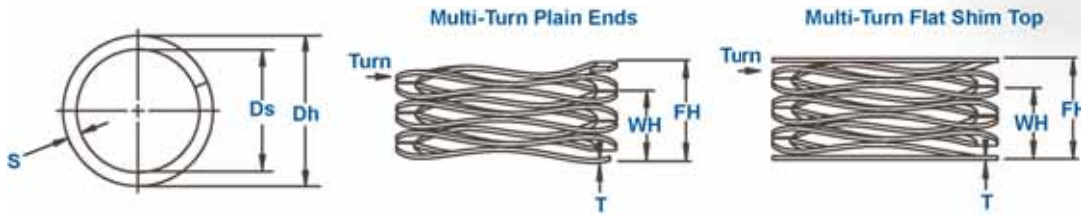

WAVE SPRING NO.	PILOTS & OPERATES IN HOUSING DIAMETER			SHAFT DIAMETER CLEARANCE Ds	LOAD (lbs.)	WORK HEIGHT		FREE HEIGHT Ref.	NUMBER OF WAVES	NUMBER OF TURNS	THICKNESS T	SECTION s	SPRING RATE Ref. lb/in.
	Dh DEC	Dh FRAC	Dh mm			WH	FH						
WSL-137 A	1.375	1-3/8	34.9	1.030	15	.075	.300	3.5	3	.012	.122	67	
WSL-137 B	1.375	1-3/8	34.9	1.030	15	.099	.400	3.5	4	.012	.122	50	
WSL-137 C	1.375	1-3/8	34.9	1.030	15	.129	.500	3.5	5	.012	.122	40	
WSL-137 D	1.375	1-3/8	34.9	1.030	15	.155	.600	3.5	6	.012	.122	34	
WSL-137 E	1.375	1-3/8	34.9	1.030	15	.179	.700	3.5	7	.012	.122	29	
WSL-137 F	1.375	1-3/8	34.9	1.030	15	.206	.800	3.5	8	.012	.122	25	
WSL-137 G	1.375	1-3/8	34.9	1.030	15	.256	1.000	3.5	10	.012	.122	20	
WSL-137 H	1.375	1-3/8	34.9	1.030	15	.341	1.300	3.5	13	.012	.122	16	
WSL-137 I	1.375	1-3/8	34.9	1.030	15	.424	1.600	3.5	16	.012	.122	13	
WSL-137 J	1.375	1-3/8	34.9	1.030	15	.530	2.000	3.5	20	.012	.122	10	
WSM-137 A	1.375	1-3/8	34.9	1.030	25	.142	.300	3.5	3	.016	.133	158	
WSM-137 B	1.375	1-3/8	34.9	1.030	25	.186	.400	3.5	4	.016	.133	117	
WSM-137 C	1.375	1-3/8	34.9	1.030	25	.240	.500	3.5	5	.016	.133	96	
WSM-137 D	1.375	1-3/8	34.9	1.030	25	.281	.600	3.5	6	.016	.133	78	
WSM-137 E	1.375	1-3/8	34.9	1.030	25	.340	.700	3.5	7	.016	.133	69	
WSM-137 F	1.375	1-3/8	34.9	1.030	25	.384	.800	3.5	8	.016	.133	60	
WSM-137 G	1.375	1-3/8	34.9	1.030	25	.486	1.000	3.5	10	.016	.133	49	
WSM-137 H	1.375	1-3/8	34.9	1.030	25	.632	1.300	3.5	13	.016	.133	37	
WSM-137 I	1.375	1-3/8	34.9	1.030	25	.788	1.600	3.5	16	.016	.133	31	
WSM-137 J	1.375	1-3/8	34.9	1.030	25	.982	2.000	3.5	20	.016	.133	25	
WSR-137 A	1.375	1-3/8	34.9	1.030	35	.149	.300	3.5	3	.018	.133	232	
WSR-137 B	1.375	1-3/8	34.9	1.030	35	.189	.400	3.5	4	.018	.133	166	
WSR-137 C	1.375	1-3/8	34.9	1.030	35	.247	.500	3.5	5	.018	.133	138	
WSR-137 D	1.375	1-3/8	34.9	1.030	35	.287	.600	3.5	6	.018	.133	112	
WSR-137 E	1.375	1-3/8	34.9	1.030	35	.343	.700	3.5	7	.018	.133	98	
WSR-137 F	1.375	1-3/8	34.9	1.030	35	.390	.800	3.5	8	.018	.133	85	
WSR-137 G	1.375	1-3/8	34.9	1.030	35	.490	1.000	3.5	10	.018	.133	69	
WSR-137 H	1.375	1-3/8	34.9	1.030	35	.646	1.300	3.5	13	.018	.133	54	
WSR-137 I	1.375	1-3/8	34.9	1.030	35	.793	1.600	3.5	16	.018	.133	43	
WSR-137 J	1.375	1-3/8	34.9	1.030	35	1.000	2.000	3.5	20	.018	.133	35	
WSL-150 A	1.500	1-1/2	38.1	1.140	20	.129	.300	3.5	3	.016	.133	117	
WSL-150 B	1.500	1-1/2	38.1	1.140	20	.164	.400	3.5	4	.016	.133	85	
WSL-150 C	1.500	1-1/2	38.1	1.140	20	.213	.500	3.5	5	.016	.133	70	
WSL-150 D	1.500	1-1/2	38.1	1.140	20	.247	.600	3.5	6	.016	.133	57	
WSL-150 E	1.500	1-1/2	38.1	1.140	20	.301	.700	3.5	7	.016	.133	50	
WSL-150 F	1.500	1-1/2	38.1	1.140	20	.337	.800	3.5	8	.016	.133	43	
WSL-150 G	1.500	1-1/2	38.1	1.140	20	.430	1.000	3.5	10	.016	.133	35	
WSL-150 H	1.500	1-1/2	38.1	1.140	20	.565	1.300	3.5	13	.016	.133	27	
WSL-150 I	1.500	1-1/2	38.1	1.140	20	.694	1.600	3.5	16	.016	.133	22	
WSL-150 J	1.500	1-1/2	38.1	1.140	20	.866	2.000	3.5	20	.016	.133	18	

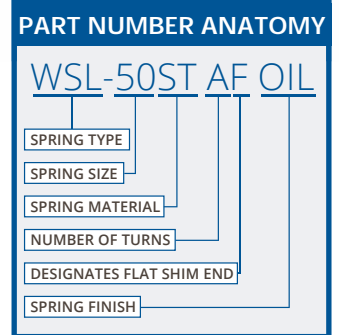

Part numbers shown in the table reflect multi-turn wave springs with plain ends.

The letters shown after the part numbers represent the number of turns.

When ordering, parts should be presented with the part number, followed by the material, and then the number of turns (i.e. WSL-37ST A, WSM-50ST B, WSR-75ST C, etc.)

For flat shim top wave springs, add an 'F' to the end of the part number (i.e. WSL-37ST AF, WSM-50ST BF, WSR-75ST CF, etc.)

Standard Material Codes:
 ST = carbon steel.
 SQ = 17-7 PH/C stainless steel.
 Special alloys available upon request.

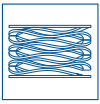

WSL, WSM, WSR WAVE SPRINGS

Multi Turn, Inch

Used for low to medium force applications with greater travel compared to single-turn springs. Utilizes nearly half the space as helical compression springs while producing the same force.

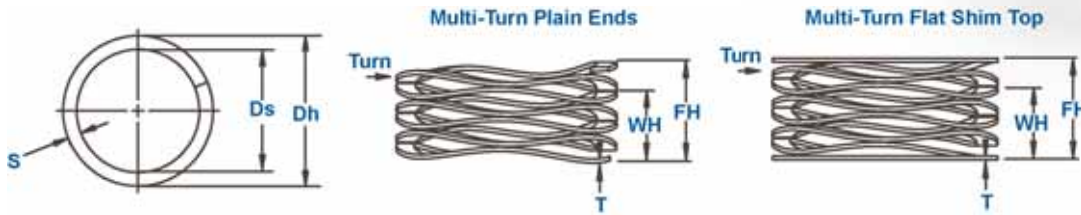

WAVE SPRING NO.	PILOTS & OPERATES IN HOUSING DIAMETER			SHAFT DIAMETER CLEARANCE	LOAD (lbs.)	WORK HEIGHT	FREE HEIGHT Ref.	NUMBER OF WAVES	NUMBER OF TURNS	THICKNESS	SECTION	SPRING RATE Ref. lb/in.
	Dh DEC	Dh FRAC	Dh mm			Ds	WH			FH	T	
WSM-150 A	1.500	1-1/2	38.1	1.140	35	.122	.300	3.5	3	.018	.133	197
WSM-150 B	1.500	1-1/2	38.1	1.140	35	.158	.400	3.5	4	.018	.133	145
WSM-150 C	1.500	1-1/2	38.1	1.140	35	.206	.500	3.5	5	.018	.133	119
WSM-150 D	1.500	1-1/2	38.1	1.140	35	.241	.600	3.5	6	.018	.133	97
WSM-150 E	1.500	1-1/2	38.1	1.140	35	.291	.700	3.5	7	.018	.133	86
WSM-150 F	1.500	1-1/2	38.1	1.140	35	.324	.800	3.5	8	.018	.133	74
WSM-150 G	1.500	1-1/2	38.1	1.140	35	.409	1.000	3.5	10	.018	.133	59
WSM-150 H	1.500	1-1/2	38.1	1.140	35	.540	1.300	3.5	13	.018	.133	46
WSM-150 I	1.500	1-1/2	38.1	1.140	35	.657	1.600	3.5	16	.018	.133	37
WSM-150 J	1.500	1-1/2	38.1	1.140	35	.835	2.000	3.5	20	.018	.133	30
WSR-150 A	1.500	1-1/2	38.1	1.140	60	.166	.300	4.5	3	.018	.133	448
WSR-150 B	1.500	1-1/2	38.1	1.140	60	.216	.400	4.5	4	.018	.133	326
WSR-150 C	1.500	1-1/2	38.1	1.140	60	.278	.500	4.5	5	.018	.133	270
WSR-150 D	1.500	1-1/2	38.1	1.140	60	.329	.600	4.5	6	.018	.133	221
WSR-150 E	1.500	1-1/2	38.1	1.140	60	.390	.700	4.5	7	.018	.133	194
WSR-150 F	1.500	1-1/2	38.1	1.140	60	.443	.800	4.5	8	.018	.133	168
WSR-150 G	1.500	1-1/2	38.1	1.140	60	.555	1.000	4.5	10	.018	.133	135
WSR-150 H	1.500	1-1/2	38.1	1.140	60	.726	1.300	4.5	13	.018	.133	105
WSR-150 I	1.500	1-1/2	38.1	1.140	60	.890	1.600	4.5	16	.018	.133	85
WSR-150 J	1.500	1-1/2	38.1	1.140	60	1.119	2.000	4.5	20	.018	.133	68
WSL-175 A	1.750	1-3/4	44.4	1.340	25	.155	.375	3.5	3	.018	.143	114
WSL-175 B	1.750	1-3/4	44.4	1.340	25	.200	.500	3.5	4	.018	.143	83
WSL-175 C	1.750	1-3/4	44.4	1.340	25	.265	.625	3.5	5	.018	.143	69
WSL-175 D	1.750	1-3/4	44.4	1.340	25	.310	.750	3.5	6	.018	.143	57
WSL-175 E	1.750	1-3/4	44.4	1.340	25	.367	.870	3.5	7	.018	.143	50
WSL-175 F	1.750	1-3/4	44.4	1.340	25	.415	1.000	3.5	8	.018	.143	43
WSL-175 G	1.750	1-3/4	44.4	1.340	25	.523	1.250	3.5	10	.018	.143	34
WSL-175 H	1.750	1-3/4	44.4	1.340	25	.638	1.500	3.5	12	.018	.143	29
WSL-175 I	1.750	1-3/4	44.4	1.340	25	.737	1.750	3.5	14	.018	.143	25
WSL-175 J	1.750	1-3/4	44.4	1.340	25	.844	2.000	3.5	16	.018	.143	22
WSM-175 A	1.750	1-3/4	44.4	1.340	50	.188	.375	4.5	3	.018	.143	267
WSM-175 B	1.750	1-3/4	44.4	1.340	50	.244	.500	4.5	4	.018	.143	195
WSM-175 C	1.750	1-3/4	44.4	1.340	50	.315	.625	4.5	5	.018	.143	161
WSM-175 D	1.750	1-3/4	44.4	1.340	50	.374	.750	4.5	6	.018	.143	133
WSM-175 E	1.750	1-3/4	44.4	1.340	50	.452	.870	4.5	7	.018	.143	120
WSM-175 F	1.750	1-3/4	44.4	1.340	50	.505	1.000	4.5	8	.018	.143	101
WSM-175 G	1.750	1-3/4	44.4	1.340	50	.629	1.250	4.5	10	.018	.143	81
WSM-175 H	1.750	1-3/4	44.4	1.340	50	.768	1.500	4.5	12	.018	.143	68
WSM-175 I	1.750	1-3/4	44.4	1.340	50	.899	1.750	4.5	14	.018	.143	59
WSM-175 J	1.750	1-3/4	44.4	1.340	50	1.026	2.000	4.5	16	.018	.143	51

PART NUMBER ANATOMY

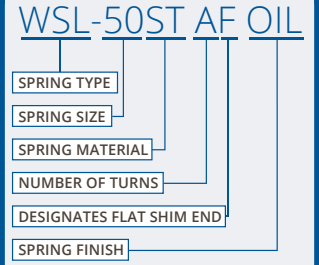

Part numbers shown in the table reflect multi-turn wave springs with plain ends.

The letters shown after the part numbers represent the number of turns.

When ordering, parts should be presented with the part number, followed by the material, and then the number of turns (i.e. WSL-37ST A, WSM-50ST B, WSR-75ST C, etc.)

For flat shim top wave springs, add an 'F' to the end of the part number (i.e. WSL-37ST AF, WSM-50ST BF, WSR-75ST CF, etc.)

Standard Material Codes:

ST = carbon steel.

SQ = 17-7 PH/C stainless steel.

Special alloys available upon request.

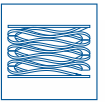

WSL, WSM, WSR WAVE SPRINGS

Multi Turn, Inch

Used for low to medium force applications with greater travel compared to single-turn springs. Utilizes nearly half the space as helical compression springs while producing the same force.

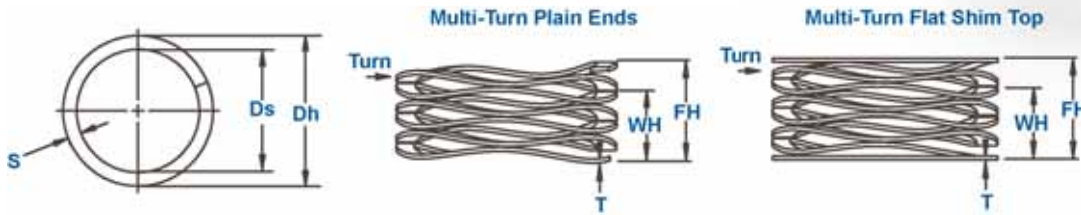

WAVE SPRING NO.	PILOTS & OPERATES IN HOUSING DIAMETER			SHAFT DIAMETER CLEARANCE Ds	LOAD (lbs.)	WORK HEIGHT	FREE HEIGHT Ref.	NUMBER OF WAVES	NUMBER OF TURNS	THICKNESS	SECTION	SPRING RATE Ref. lb/in.
	Dh DEC	Dh FRAC	Dh mm			WH	FH			T	s	
WSR-175 A	1.750	1-3/4	44.4	1.340	90	.232	.375	4.5	3	.024	.148	629
WSR-175 B	1.750	1-3/4	44.4	1.340	90	.314	.500	4.5	4	.024	.148	484
WSR-175 C	1.750	1-3/4	44.4	1.340	90	.409	.625	4.5	5	.024	.148	417
WSR-175 D	1.750	1-3/4	44.4	1.340	90	.482	.750	4.5	6	.024	.148	336
WSR-175 E	1.750	1-3/4	44.4	1.340	90	.577	.870	4.5	7	.024	.148	307
WSR-175 F	1.750	1-3/4	44.4	1.340	90	.651	1.000	4.5	8	.024	.148	258
WSR-175 G	1.750	1-3/4	44.4	1.340	90	.813	1.250	4.5	10	.024	.148	206
WSR-175 H	1.750	1-3/4	44.4	1.340	90	.980	1.500	4.5	12	.024	.148	173
WSR-175 I	1.750	1-3/4	44.4	1.340	90	1.147	1.750	4.5	14	.024	.148	149
WSR-175 J	1.750	1-3/4	44.4	1.340	90	1.317	2.000	4.5	16	.024	.148	132
WSL-200 A	2.000	2	50.8	1.600	25	.094	.375	3.5	3	.018	.143	89
WSL-200 B	2.000	2	50.8	1.600	25	.120	.500	3.5	4	.018	.143	66
WSL-200 C	2.000	2	50.8	1.600	25	.158	.625	3.5	5	.018	.143	54
WSL-200 D	2.000	2	50.8	1.600	25	.179	.750	3.5	6	.018	.143	44
WSL-200 E	2.000	2	50.8	1.600	25	.217	.870	3.5	7	.018	.143	38
WSL-200 F	2.000	2	50.8	1.600	25	.243	1.000	3.5	8	.018	.143	33
WSL-200 G	2.000	2	50.8	1.600	25	.306	1.250	3.5	10	.018	.143	26
WSL-200 H	2.000	2	50.8	1.600	25	.365	1.500	3.5	12	.018	.143	22
WSL-200 I	2.000	2	50.8	1.600	25	.433	1.750	3.5	14	.018	.143	19
WSL-200 J	2.000	2	50.8	1.600	25	.490	2.000	3.5	16	.018	.143	17
WSM-200 A	2.000	2	50.8	1.600	50	.140	.375	4.5	3	.018	.143	213
WSM-200 B	2.000	2	50.8	1.600	50	.184	.500	4.5	4	.018	.143	158
WSM-200 C	2.000	2	50.8	1.600	50	.245	.625	4.5	5	.018	.143	132
WSM-200 D	2.000	2	50.8	1.600	50	.278	.750	4.5	6	.018	.143	106
WSM-200 E	2.000	2	50.8	1.600	50	.345	.870	4.5	7	.018	.143	95
WSM-200 F	2.000	2	50.8	1.600	50	.395	1.000	4.5	8	.018	.143	83
WSM-200 G	2.000	2	50.8	1.600	50	.498	1.250	4.5	10	.018	.143	66
WSM-200 H	2.000	2	50.8	1.600	50	.593	1.500	4.5	12	.018	.143	55
WSM-200 I	2.000	2	50.8	1.600	50	.694	1.750	4.5	14	.018	.143	47
WSM-200 J	2.000	2	50.8	1.600	50	.800	2.000	4.5	16	.018	.143	42
WSR-200 A	2.000	2	50.8	1.600	90	.197	.375	4.5	3	.024	.148	506
WSR-200 B	2.000	2	50.8	1.600	90	.258	.500	4.5	4	.024	.148	372
WSR-200 C	2.000	2	50.8	1.600	90	.332	.625	4.5	5	.024	.148	307
WSR-200 D	2.000	2	50.8	1.600	90	.389	.750	4.5	6	.024	.148	249
WSR-200 E	2.000	2	50.8	1.600	90	.465	.870	4.5	7	.024	.148	222
WSR-200 F	2.000	2	50.8	1.600	90	.525	1.000	4.5	8	.024	.148	189
WSR-200 G	2.000	2	50.8	1.600	90	.661	1.250	4.5	10	.024	.148	153
WSR-200 H	2.000	2	50.8	1.600	90	.781	1.500	4.5	12	.024	.148	125
WSR-200 I	2.000	2	50.8	1.600	90	.941	1.750	4.5	14	.024	.148	111
WSR-200 J	2.000	2	50.8	1.600	90	1.069	2.000	4.5	16	.024	.148	97

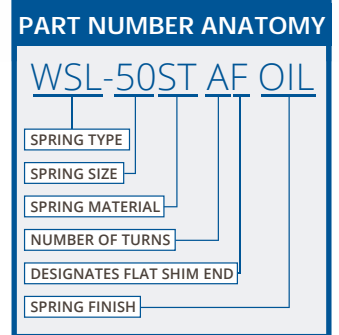

Part numbers shown in the table reflect multi-turn wave springs with plain ends.

The letters shown after the part numbers represent the number of turns.

When ordering, parts should be presented with the part number, followed by the material, and then the number of turns (i.e. WSL-37ST A, WSM-50ST B, WSR-75ST C, etc.)

For flat shim top wave springs, add an 'F' to the end of the part number (i.e. WSL-37ST AF, WSM-50ST BF, WSR-75ST CF, etc.)

Standard Material Codes:
 ST = carbon steel.
 SQ = 17-7 PH/C stainless steel.
 Special alloys available upon request.

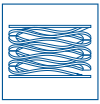

MWL, MWM, MWR WAVE SPRINGS

Multi Turn, Metric

Used for low to medium force applications with greater travel compared to single-turn springs. Utilizes nearly half the space as helical compression springs while producing the same force.

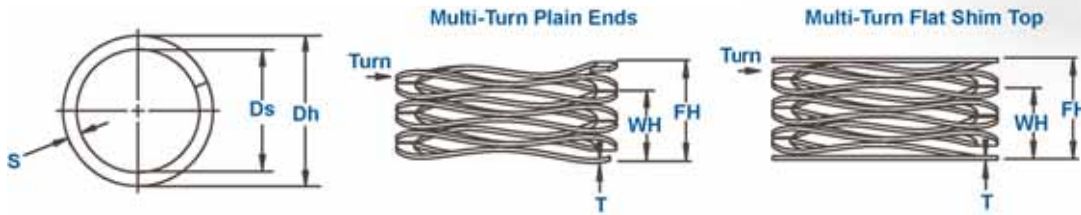

WAVE SPRING NO.	PILOTS & OPERATES IN HOUSING DIAMETER	SHAFT DIAMETER CLEARANCE	LOAD (N)	WORK HEIGHT	FREE HEIGHT Ref.	NUMBER OF WAVES	NUMBER OF TURNS	THICKNESS	SECTION	SPRING RATE Ref.
	Dh mm			Ds	WH			FH	T	
MWL-6 A*	6	4	6	0.61	1.52	2.5	3	0.13	0.51	6.56
MWL-6 B*	6	4	6	0.81	2.03	2.5	4	0.13	0.51	4.92
MWL-6 C*	6	4	6	1.02	2.54	2.5	5	0.13	0.51	3.94
MWL-6 D*	6	4	6	1.22	3.05	2.5	6	0.13	0.51	3.28
MWL-6 E*	6	4	6	1.42	3.56	2.5	7	0.13	0.51	2.81
MWL-6 F*	6	4	6	1.63	4.06	2.5	8	0.13	0.51	2.46
MWL-6 G*	6	4	6	1.83	4.57	2.5	9	0.13	0.51	2.19
MWL-6 H*	6	4	6	2.24	5.59	2.5	11	0.13	0.51	1.79
MWL-6 I*	6	4	6	2.64	6.60	2.5	13	0.13	0.51	1.51
MWM-6 A*	6	4	12	0.74	1.52	2.5	3	0.15	0.61	15.24
MWM-6 B*	6	4	12	0.97	2.03	2.5	4	0.15	0.61	11.25
MWM-6 C*	6	4	12	1.22	2.54	2.5	5	0.15	0.61	9.09
MWM-6 D*	6	4	12	1.47	3.05	2.5	6	0.15	0.61	7.62
MWM-6 E*	6	4	12	1.70	3.56	2.5	7	0.15	0.61	6.47
MWM-6 F*	6	4	12	1.96	4.06	2.5	8	0.15	0.61	5.69
MWM-6 G*	6	4	12	2.18	4.57	2.5	9	0.15	0.61	5.03
MWM-6 H*	6	4	12	2.69	5.59	2.5	11	0.15	0.61	4.14
MWM-6 I*	6	4	12	3.18	6.60	2.5	13	0.15	0.61	3.50
MWL-8 A	8	5	15	1.70	2.82	2.5	3	0.20	0.81	13.42
MWL-8 B	8	5	15	2.39	3.76	2.5	4	0.20	0.81	10.94
MWL-8 C	8	5	15	2.74	4.70	2.5	5	0.20	0.81	7.67
MWL-8 D	8	5	15	3.56	5.64	2.5	6	0.20	0.81	7.20
MWL-8 E	8	5	15	4.01	6.58	2.5	7	0.20	0.81	5.85
MWL-8 F	8	5	15	4.57	7.52	2.5	8	0.20	0.81	5.09
MWL-8 G	8	5	15	5.26	8.46	2.5	9	0.20	0.81	4.69
MWL-8 H	8	5	15	6.35	10.34	2.5	11	0.20	0.81	3.76
MWL-8 I	8	5	15	7.37	12.22	2.5	13	0.20	0.81	3.09
MWM-8 A	8	5	30	1.78	2.82	2.5	3	0.25	0.81	28.81
MWM-8 B	8	5	30	2.54	3.76	2.5	4	0.25	0.81	24.61
MWM-8 C	8	5	30	3.05	4.70	2.5	5	0.25	0.81	18.17
MWM-8 D	8	5	30	3.81	5.64	2.5	6	0.25	0.81	16.40
MWM-8 E	8	5	30	4.32	6.58	2.5	7	0.25	0.81	13.27
MWM-8 F	8	5	30	4.95	7.52	2.5	8	0.25	0.81	11.69
MWM-8 G	8	5	30	5.59	8.46	2.5	9	0.25	0.81	10.45
MWM-8 H	8	5	30	6.86	10.34	2.5	11	0.25	0.81	8.62
MWM-8 I	8	5	30	7.87	12.22	2.5	13	0.25	0.81	6.91

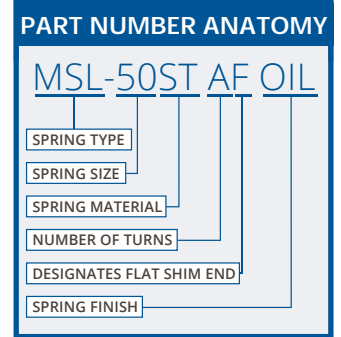

Part numbers shown in the table reflect multi-turn wave springs with plain ends.

The letters shown after the part numbers represent the number of turns.

When ordering, parts should be presented with the part number, followed by the material, and then the number of turns (i.e. MWL-5ST A, MWM-20ST B, MWR-25ST C, etc.)

For flat shim top wave springs, add an 'F' to the end of the part number (i.e. MWL-6ST AF, MWM-20ST BF, MWR-25ST CF, etc.)

Standard Material Codes:

ST = carbon steel.
 SQ = 17-7 PH/C stainless steel.
 Special alloys available upon request.

ALL DIMENSIONS IN MILLIMETERS UNLESS OTHERWISE SPECIFIED.

*Not available with shim ends

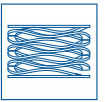

MWL, MWM, MWR WAVE SPRINGS

Multi Turn, Metric

Used for low to medium force applications with greater travel compared to single-turn springs. Utilizes nearly half the space as helical compression springs while producing the same force.

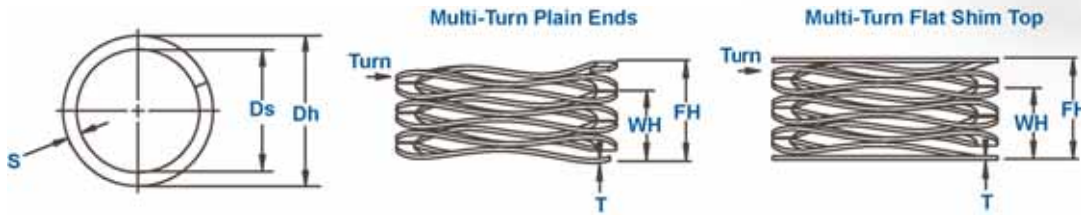

WAVE SPRING NO.	PILOTS & OPERATES IN HOUSING DIAMETER	SHAFT DIAMETER CLEARANCE	LOAD (N)	WORK HEIGHT	FREE HEIGHT Ref.	NUMBER OF WAVES	NUMBER OF TURNS	THICKNESS	SECTION	SPRING RATE Ref.
	Dh mm	Ds		WH	FH			T	s	
MWL-10 A	10	7	18	1.91	3.96	2.5	3	0.20	0.81	8.75
MWL-10 B	10	7	18	2.54	5.28	2.5	4	0.20	0.81	6.56
MWL-10 C	10	7	18	3.15	6.60	2.5	5	0.20	0.81	5.21
MWL-10 D	10	7	18	3.78	7.92	2.5	6	0.20	0.81	4.35
MWL-10 E	10	7	18	4.42	9.25	2.5	7	0.20	0.81	3.73
MWL-10 F	10	7	18	5.05	10.57	2.5	8	0.20	0.81	3.27
MWL-10 G	10	7	18	5.69	11.89	2.5	9	0.20	0.81	2.90
MWL-10 H	10	7	18	6.32	13.21	2.5	10	0.20	0.81	2.61
MWL-10 I	10	7	18	6.96	14.53	2.5	11	0.20	0.81	2.38
MWM-10 A	10	7	35	2.03	3.96	2.5	3	0.28	0.81	18.13
MWM-10 B	10	7	35	2.79	5.28	2.5	4	0.28	0.81	14.06
MWM-10 C	10	7	35	3.56	6.60	2.5	5	0.28	0.81	11.48
MWM-10 D	10	7	35	4.32	7.92	2.5	6	0.28	0.81	9.70
MWM-10 E	10	7	35	5.08	9.25	2.5	7	0.28	0.81	8.40
MWM-10 F	10	7	35	5.84	10.57	2.5	8	0.28	0.81	7.41
MWM-10 G	10	7	35	6.60	11.89	2.5	9	0.28	0.81	6.62
MWM-10 H	10	7	35	7.37	13.21	2.5	10	0.28	0.81	5.99
MWM-10 I	10	7	35	8.13	14.53	2.5	11	0.28	0.81	5.47
MWL-12 A	12	9	20	1.47	4.34	2.5	3	0.20	1.02	6.97
MWL-12 B	12	9	20	1.98	5.79	2.5	4	0.20	1.02	5.25
MWL-12 C	12	9	20	2.46	7.24	2.5	5	0.20	1.02	4.19
MWL-12 D	12	9	20	2.95	8.69	2.5	6	0.20	1.02	3.48
MWL-12 E	12	9	20	3.45	10.13	2.5	7	0.20	1.02	2.99
MWL-12 F	12	9	20	3.94	11.58	2.5	8	0.20	1.02	2.62
MWL-12 G	12	9	20	4.45	13.03	2.5	9	0.20	1.02	2.33
MWL-12 H	12	9	20	4.93	14.48	2.5	10	0.20	1.02	2.09
MWL-12 I	12	9	20	5.44	15.93	2.5	11	0.20	1.02	1.91
MWM-12 A	12	8.5	40	2.36	4.34	2.5	3	0.28	1.17	20.19
MWM-12 B	12	8.5	40	3.18	5.79	2.5	4	0.28	1.17	15.29
MWM-12 C	12	8.5	40	3.96	7.24	2.5	5	0.28	1.17	12.21
MWM-12 D	12	8.5	40	4.75	8.69	2.5	6	0.28	1.17	10.16
MWM-12 E	12	8.5	40	5.54	10.13	2.5	7	0.28	1.17	8.70
MWM-12 F	12	8.5	40	6.32	11.58	2.5	8	0.28	1.17	7.61
MWM-12 G	12	8.5	40	7.11	13.03	2.5	9	0.28	1.17	6.76
MWM-12 H	12	8.5	40	7.92	14.48	2.5	10	0.28	1.17	6.10
MWM-12 I	12	8.5	40	8.71	15.93	2.5	11	0.28	1.17	5.55

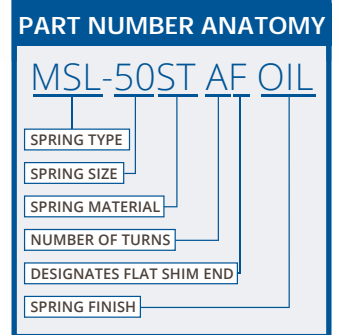

Part numbers shown in the table reflect multi-turn wave springs with plain ends.

The letters shown after the part numbers represent the number of turns.

When ordering, parts should be presented with the part number, followed by the material, and then the number of turns (i.e. MWL-5ST A, MWM-20ST B, MWR-25ST C, etc.)

For flat shim top wave springs, add an 'F' to the end of the part number (i.e. MWL-6ST AF, MWM-20ST BF, MWR-25ST CF, etc.)

Standard Material Codes:

ST = carbon steel.
 SQ = 17-7 PH/C stainless steel.
 Special alloys available upon request.

ALL DIMENSIONS IN MILLIMETERS UNLESS OTHERWISE SPECIFIED.

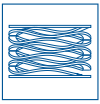

MWL, MWM, MWR WAVE SPRINGS

Multi Turn, Metric

Used for low to medium force applications with greater travel compared to single-turn springs. Utilizes nearly half the space as helical compression springs while producing the same force.

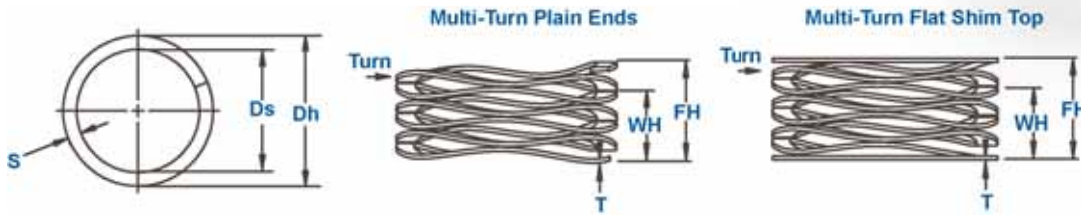

WAVE SPRING NO.	PILOTS & OPERATES IN HOUSING DIAMETER	SHAFT DIAMETER CLEARANCE	LOAD (N)	WORK HEIGHT	FREE HEIGHT Ref.	NUMBER OF WAVES	NUMBER OF TURNS	THICKNESS	SECTION	SPRING RATE Ref.
	Dh mm	Ds		WH	FH			T	s	
MWR-12 A	12	8.5	60	1.98	4.34	2.5	3	0.30	1.14	25.40
MWR-12 B	12	8.5	60	2.64	5.79	2.5	4	0.30	1.14	19.05
MWR-12 C	12	8.5	60	3.30	7.24	2.5	5	0.30	1.14	15.24
MWR-12 D	12	8.5	60	3.99	8.69	2.5	6	0.30	1.14	12.77
MWR-12 E	12	8.5	60	4.65	10.13	2.5	7	0.30	1.14	10.94
MWR-12 F	12	8.5	60	5.31	11.58	2.5	8	0.30	1.14	9.56
MWR-12 G	12	8.5	60	5.97	13.03	2.5	9	0.30	1.14	8.50
MWR-12 H	12	8.5	60	6.63	14.48	2.5	10	0.30	1.14	7.64
MWR-12 I	12	8.5	60	7.29	15.93	2.5	11	0.30	1.14	6.95
MWL-14 A	14	10	22	2.18	4.95	2.5	3	0.23	1.47	7.95
MWL-14 B	14	10	22	2.95	6.60	2.5	4	0.23	1.47	6.01
MWL-14 C	14	10	22	3.71	8.26	2.5	5	0.23	1.47	4.84
MWL-14 D	14	10	22	4.52	9.91	2.5	6	0.23	1.47	4.09
MWL-14 E	14	10	22	5.33	11.56	2.5	7	0.23	1.47	3.54
MWL-14 F	14	10	22	6.17	13.21	2.5	8	0.23	1.47	3.13
MWL-14 G	14	10	22	7.01	14.86	2.5	9	0.23	1.47	2.80
MWL-14 H	14	10	22	7.85	16.51	2.5	10	0.23	1.47	2.54
MWL-14 I	14	10	22	8.71	18.16	2.5	11	0.23	1.47	2.33
MWM-14 A	14	10	50	2.18	4.95	2.5	3	0.30	1.52	18.06
MWM-14 B	14	10	50	2.95	6.60	2.5	4	0.30	1.52	13.67
MWM-14 C	14	10	50	3.71	8.26	2.5	5	0.30	1.52	11.00
MWM-14 D	14	10	50	4.52	9.91	2.5	6	0.30	1.52	9.29
MWM-14 E	14	10	50	5.33	11.56	2.5	7	0.30	1.52	8.03
MWM-14 F	14	10	50	6.17	13.21	2.5	8	0.30	1.52	7.11
MWM-14 G	14	10	50	7.01	14.86	2.5	9	0.30	1.52	6.37
MWM-14 H	14	10	50	7.85	16.51	2.5	10	0.30	1.52	5.77
MWM-14 I	14	10	50	8.71	18.16	2.5	11	0.30	1.52	5.29
MWR-14 A	14	9	80	3.15	4.95	2.5	3	0.38	1.52	44.36
MWR-14 B	14	9	80	4.19	6.60	2.5	4	0.38	1.52	33.15
MWR-14 C	14	9	80	5.26	8.26	2.5	5	0.38	1.52	26.69
MWR-14 D	14	9	80	6.30	9.91	2.5	6	0.38	1.52	22.18
MWR-14 E	14	9	80	7.34	11.56	2.5	7	0.38	1.52	18.97
MWR-14 F	14	9	80	8.41	13.21	2.5	8	0.38	1.52	16.66
MWR-14 G	14	9	80	9.45	14.86	2.5	9	0.38	1.52	14.79
MWR-14 H	14	9	80	10.49	16.51	2.5	10	0.38	1.52	13.29
MWR-14 I	14	9	80	11.56	18.16	2.5	11	0.38	1.52	12.11

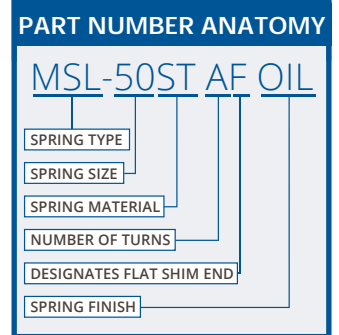

Part numbers shown in the table reflect multi-turn wave springs with plain ends.

The letters shown after the part numbers represent the number of turns.

When ordering, parts should be presented with the part number, followed by the material, and then the number of turns (i.e. MWL-5ST A, MWM-20ST B, MWR-25ST C, etc.)

For flat shim top wave springs, add an 'F' to the end of the part number (i.e. MWL-6ST AF, MWM-20ST BF, MWR-25ST CF, etc.)

Standard Material Codes:

ST = carbon steel.
 SQ = 17-7 PH/C stainless steel.
 Special alloys available upon request.

ALL DIMENSIONS IN MILLIMETERS UNLESS OTHERWISE SPECIFIED.

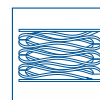

MWL, MWM, MWR WAVE SPRINGS

Multi Turn, Metric

Used for low to medium force applications with greater travel compared to single-turn springs. Utilizes nearly half the space as helical compression springs while producing the same force.

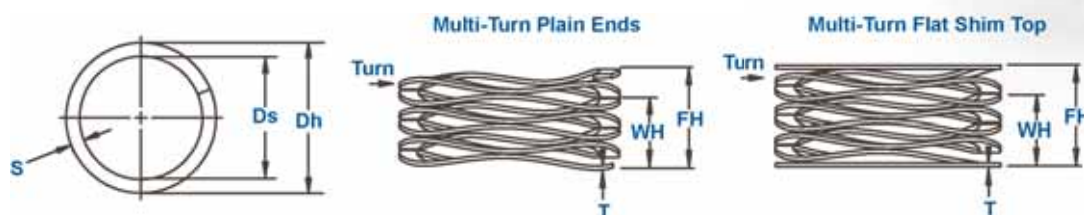

WAVE SPRING NO.	PILOTS & OPERATES IN HOUSING DIAMETER	SHAFT DIAMETER CLEARANCE	LOAD (N)	WORK HEIGHT	FREE HEIGHT Ref.	NUMBER OF WAVES	NUMBER OF TURNS	THICKNESS	SECTION	SPRING RATE Ref.
	Dh mm	Ds		WH	FH			T	s	
MWL-15 A	15	11	25	2.57	5.18	2.5	3	0.25	1.47	9.56
MWL-15 B	15	11	25	3.43	6.91	2.5	4	0.25	1.47	7.18
MWL-15 C	15	11	25	4.27	8.64	2.5	5	0.25	1.47	5.72
MWL-15 D	15	11	25	5.13	10.36	2.5	6	0.25	1.47	4.78
MWL-15 E	15	11	25	5.99	12.09	2.5	7	0.25	1.47	4.10
MWL-15 F	15	11	25	6.83	13.82	2.5	8	0.25	1.47	3.58
MWL-15 G	15	11	25	7.70	15.54	2.5	9	0.25	1.47	3.19
MWL-15 H	15	11	25	8.53	17.27	2.5	10	0.25	1.47	2.86
MWL-15 I	15	11	25	9.40	19.00	2.5	11	0.25	1.47	2.60
MWM-15 A	15	10	50	3.43	5.18	3.5	3	0.23	1.47	28.53
MWM-15 B	15	10	50	4.57	6.91	3.5	4	0.23	1.47	21.40
MWM-15 C	15	10	50	5.72	8.64	3.5	5	0.23	1.47	17.12
MWM-15 D	15	10	50	6.86	10.36	3.5	6	0.23	1.47	14.26
MWM-15 E	15	10	50	8.00	12.09	3.5	7	0.23	1.47	12.23
MWM-15 F	15	10	50	9.14	13.82	3.5	8	0.23	1.47	10.70
MWM-15 G	15	10	50	10.29	15.54	3.5	9	0.23	1.47	9.51
MWM-15 H	15	10	50	11.43	17.27	3.5	10	0.23	1.47	8.56
MWM-15 I	15	10	50	12.57	19.00	3.5	11	0.23	1.47	7.78
MWR-15 A	15	10	80	3.20	5.18	3.5	3	0.25	1.47	40.38
MWR-15 B	15	10	80	4.19	6.91	3.5	4	0.25	1.47	29.44
MWR-15 C	15	10	80	5.23	8.64	3.5	5	0.25	1.47	23.50
MWR-15 D	15	10	80	6.27	10.36	3.5	6	0.25	1.47	19.56
MWR-15 E	15	10	80	7.32	12.09	3.5	7	0.25	1.47	16.75
MWR-15 F	15	10	80	8.36	13.82	3.5	8	0.25	1.47	14.65
MWR-15 G	15	10	80	9.40	15.54	3.5	9	0.25	1.47	13.01
MWR-15 H	15	10	80	10.46	17.27	3.5	10	0.25	1.47	11.75
MWR-15 I	15	10	80	11.51	19.00	3.5	11	0.25	1.47	10.68
MWL-16 A	16	11	25	2.11	5.41	2.5	3	0.25	1.47	7.57
MWL-16 B	16	11	25	2.79	7.21	2.5	4	0.25	1.47	5.66
MWL-16 C	16	11	25	3.51	9.02	2.5	5	0.25	1.47	4.54
MWL-16 D	16	11	25	4.19	10.82	2.5	6	0.25	1.47	3.77
MWL-16 E	16	11	25	4.90	12.62	2.5	7	0.25	1.47	3.24
MWL-16 F	16	11	25	6.30	16.23	2.5	9	0.25	1.47	2.52
MWL-16 G	16	11	25	7.70	19.84	2.5	11	0.25	1.47	2.06
MWL-16 H	16	11	25	9.09	23.44	2.5	13	0.25	1.47	1.74

PART NUMBER ANATOMY

MSL-50ST AF OIL

SPRING TYPE

SPRING SIZE

SPRING MATERIAL

NUMBER OF TURNS

DESIGNATES FLAT SHIM END

SPRING FINISH

Part numbers shown in the table reflect multi-turn wave springs with plain ends.

The letters shown after the part numbers represent the number of turns.

When ordering, parts should be presented with the part number, followed by the material, and then the number of turns (i.e. MWL-5ST A, MWM-20ST B, MWR-25ST C, etc.)

For flat shim top wave springs, add an 'F' to the end of the part number (i.e. MWL-6ST AF, MWM-20ST BF, MWR-25ST CF, etc.)

Standard Material Codes:

ST = carbon steel.

SQ = 17-7 PH/C stainless steel.

Special alloys available upon request.

ALL DIMENSIONS IN MILLIMETERS UNLESS OTHERWISE SPECIFIED.

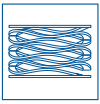

MWL, MWM, MWR WAVE SPRINGS

Multi Turn, Metric

Used for low to medium force applications with greater travel compared to single-turn springs. Utilizes nearly half the space as helical compression springs while producing the same force.

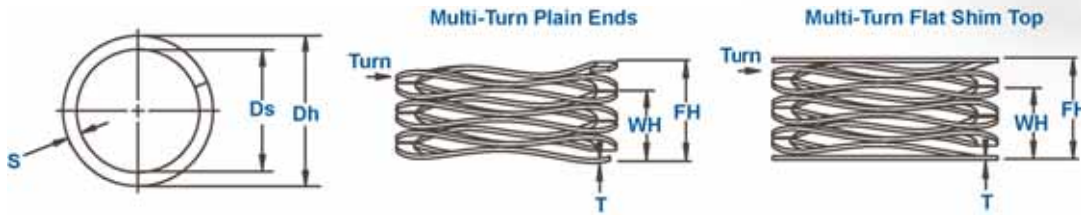

WAVE SPRING NO.	PILOTS & OPERATES IN HOUSING DIAMETER	SHAFT DIAMETER CLEARANCE	LOAD (N)	WORK HEIGHT	FREE HEIGHT Ref.	NUMBER OF WAVES	NUMBER OF TURNS	THICKNESS	SECTION	SPRING RATE Ref.
	Dh mm			Ds	WH			FH	T	
MWM-16 A	16	11	55	3.63	5.41	3.5	3	0.25	1.47	30.93
MWM-16 B	16	11	55	4.83	7.21	3.5	4	0.25	1.47	23.04
MWM-16 C	16	11	55	6.05	9.02	3.5	5	0.25	1.47	18.51
MWM-16 D	16	11	55	7.24	10.82	3.5	6	0.25	1.47	15.36
MWM-16 E	16	11	55	8.46	12.62	3.5	7	0.25	1.47	13.20
MWM-16 F	16	11	55	10.87	16.23	3.5	9	0.25	1.47	10.26
MWM-16 G	16	11	55	13.28	19.84	3.5	11	0.25	1.47	8.39
MWM-16 H	16	11	55	15.70	23.44	3.5	13	0.25	1.47	7.10
MWR-16 A	16	11	90	3.30	5.41	3.5	3	0.30	1.52	42.69
MWR-16 B	16	11	90	4.57	7.21	3.5	4	0.30	1.52	34.07
MWR-16 C	16	11	90	5.59	9.02	3.5	5	0.30	1.52	26.25
MWR-16 D	16	11	90	6.86	10.82	3.5	6	0.30	1.52	22.71
MWR-16 E	16	11	90	7.87	12.62	3.5	7	0.30	1.52	18.95
MWR-16 F	16	11	90	10.16	16.23	3.5	9	0.30	1.52	14.83
MWR-16 G	16	11	90	12.45	19.84	3.5	11	0.30	1.52	12.18
MWR-16 H	16	11	90	14.73	23.44	3.5	13	0.30	1.52	10.33
MWL-18 A	18	13	30	3.63	5.72	3.5	3	0.20	1.80	14.40
MWL-18 B	18	13	30	4.75	7.62	3.5	4	0.20	1.80	10.45
MWL-18 C	18	13	30	5.94	9.53	3.5	5	0.20	1.80	8.38
MWL-18 D	18	13	30	7.14	11.43	3.5	6	0.20	1.80	6.99
MWL-18 E	18	13	30	8.31	13.34	3.5	7	0.20	1.80	5.97
MWL-18 F	18	13	30	10.69	17.15	3.5	9	0.20	1.80	4.65
MWL-18 G	18	13	30	14.25	22.86	3.5	12	0.20	1.80	3.48
MWM-18 A	18	13	55	3.68	5.72	3.5	3	0.25	1.83	27.07
MWM-18 B	18	13	55	4.98	7.62	3.5	4	0.25	1.83	20.82
MWM-18 C	18	13	55	6.22	9.53	3.5	5	0.25	1.83	16.66
MWM-18 D	18	13	55	7.47	11.43	3.5	6	0.25	1.83	13.88
MWM-18 E	18	13	55	8.74	13.34	3.5	7	0.25	1.83	11.96
MWM-18 F	18	13	55	11.23	17.15	3.5	9	0.25	1.83	9.29
MWM-18 G	18	13	55	14.96	22.86	3.5	12	0.25	1.83	6.96
MWR-18 A	18	13	90	3.84	5.72	3.5	3	0.30	1.83	47.88
MWR-18 B	18	13	90	5.13	7.62	3.5	4	0.30	1.83	36.16
MWR-18 C	18	13	90	6.40	9.53	3.5	5	0.30	1.83	28.81
MWR-18 D	18	13	90	7.70	11.43	3.5	6	0.30	1.83	24.10
MWR-18 E	18	13	90	8.97	13.34	3.5	7	0.30	1.83	20.60
MWR-18 F	18	13	90	11.53	17.15	3.5	9	0.30	1.83	16.03
MWR-18 G	18	13	90	15.37	22.86	3.5	12	0.30	1.83	12.01

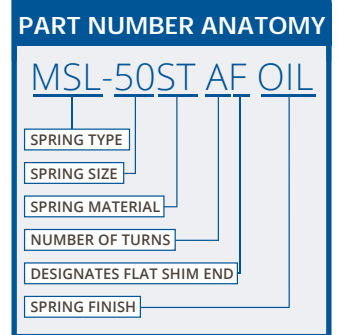

Part numbers shown in the table reflect multi-turn wave springs with plain ends.

The letters shown after the part numbers represent the number of turns.

When ordering, parts should be presented with the part number, followed by the material, and then the number of turns (i.e. MWL-5ST A, MWM-20ST B, MWR-25ST C, etc.)

For flat shim top wave springs, add an 'F' to the end of the part number (i.e. MWL-6ST AF, MWM-20ST BF, MWR-25ST CF, etc.)

Standard Material Codes:
 ST = carbon steel.
 SQ = 17-7 PH/C stainless steel.
 Special alloys available upon request.

ALL DIMENSIONS IN MILLIMETERS UNLESS OTHERWISE SPECIFIED.

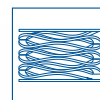

MWL, MWM, MWR WAVE SPRINGS

Multi Turn, Metric

Used for low to medium force applications with greater travel compared to single-turn springs. Utilizes nearly half the space as helical compression springs while producing the same force.

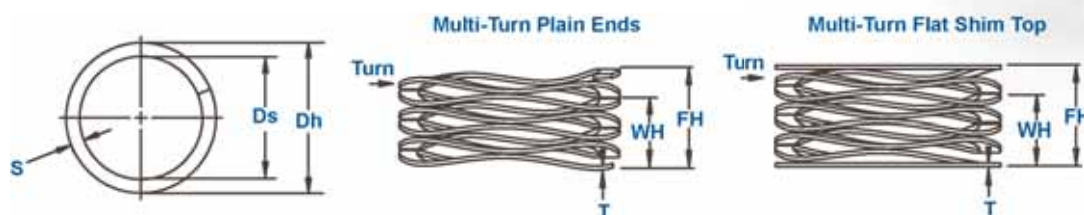

WAVE SPRING NO.	PILOTS & OPERATES IN HOUSING DIAMETER	SHAFT DIAMETER CLEARANCE	LOAD (N)	WORK HEIGHT	FREE HEIGHT Ref.	NUMBER OF WAVES	NUMBER OF TURNS	THICKNESS	SECTION	SPRING RATE Ref.
	Dh mm	Ds		WH	FH			T	s	N/mm
MWL-20 A	20	15	35	2.72	6.32	3.5	3	0.20	1.80	9.70
MWL-20 B	20	15	35	3.61	8.43	3.5	4	0.20	1.80	7.25
MWL-20 C	20	15	35	4.52	10.54	3.5	5	0.20	1.80	5.81
MWL-20 D	20	15	35	5.41	12.65	3.5	6	0.20	1.80	4.83
MWL-20 E	20	15	35	6.32	14.76	3.5	7	0.20	1.80	4.15
MWL-20 F	20	15	35	8.13	18.97	3.5	9	0.20	1.80	3.23
MWL-20 G	20	15	35	10.82	25.30	3.5	12	0.20	1.80	2.42
MWM-20 A	20	14	70	3.05	6.32	3.5	3	0.25	1.98	21.36
MWM-20 B	20	14	70	4.06	8.43	3.5	4	0.25	1.98	16.02
MWM-20 C	20	14	70	5.08	10.54	3.5	5	0.25	1.98	12.82
MWM-20 D	20	14	70	6.27	12.65	3.5	6	0.25	1.98	10.98
MWM-20 E	20	14	70	7.32	14.76	3.5	7	0.25	1.98	9.41
MWM-20 F	20	14	70	9.17	18.97	3.5	9	0.25	1.98	7.14
MWM-20 G	20	14	70	12.22	25.30	3.5	12	0.25	1.98	5.35
MWR-20 A	20	14	100	4.24	6.32	3.5	3	0.33	2.01	48.01
MWR-20 B	20	14	100	5.66	8.43	3.5	4	0.33	2.01	36.12
MWR-20 C	20	14	100	7.06	10.54	3.5	5	0.33	2.01	28.74
MWR-20 D	20	14	100	8.48	12.65	3.5	6	0.33	2.01	24.01
MWR-20 E	20	14	100	9.91	14.76	3.5	7	0.33	2.01	20.61
MWR-20 F	20	14	100	12.73	18.97	3.5	9	0.33	2.01	16.00
MWR-20 G	20	14	100	16.97	25.30	3.5	12	0.33	2.01	12.00
MWL-25 A	25	19	50	2.06	6.63	3.5	3	0.25	2.18	10.94
MWL-25 B	25	19	50	2.74	8.84	3.5	4	0.25	2.18	8.20
MWL-25 C	25	19	50	3.43	11.05	3.5	5	0.25	2.18	6.56
MWL-25 D	25	19	50	4.11	13.26	3.5	6	0.25	2.18	5.47
MWL-25 E	25	19	50	4.80	15.47	3.5	7	0.25	2.18	4.69
MWL-25 F	25	19	50	6.20	19.89	3.5	9	0.25	2.18	3.65
MWL-25 G	25	19	50	8.26	26.52	3.5	12	0.25	2.18	2.74
MWM-25 A	25	19	80	2.95	6.63	3.5	3	0.30	2.39	21.72
MWM-25 B	25	19	80	3.94	8.84	3.5	4	0.30	2.39	16.32
MWM-25 C	25	19	80	4.90	11.05	3.5	5	0.30	2.39	13.01
MWM-25 D	25	19	80	5.89	13.26	3.5	6	0.30	2.39	10.86
MWM-25 E	25	19	80	6.88	15.47	3.5	7	0.30	2.39	9.32
MWM-25 F	25	19	80	8.84	19.89	3.5	9	0.30	2.39	7.24
MWM-25 G	25	19	80	11.79	26.52	3.5	12	0.30	2.39	5.43

PART NUMBER ANATOMY

MSL-50ST AF OIL

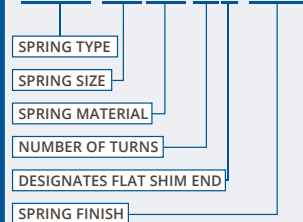

Part numbers shown in the table reflect multi-turn wave springs with plain ends.

The letters shown after the part numbers represent the number of turns.

When ordering, parts should be presented with the part number, followed by the material, and then the number of turns (i.e. MWL-5ST A, MWM-20ST B, MWR-25ST C, etc.)

For flat shim top wave springs, add an 'F' to the end of the part number (i.e. MWL-6ST AF, MWM-20ST BF, MWR-25ST CF, etc.)

Standard Material Codes:

ST = carbon steel.
 SQ = 17-7 PH/C stainless steel.
 Special alloys available upon request.

ALL DIMENSIONS IN MILLIMETERS UNLESS OTHERWISE SPECIFIED.

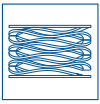

MWL, MWM, MWR WAVE SPRINGS

Multi Turn, Metric

Used for low to medium force applications with greater travel compared to single-turn springs. Utilizes nearly half the space as helical compression springs while producing the same force.

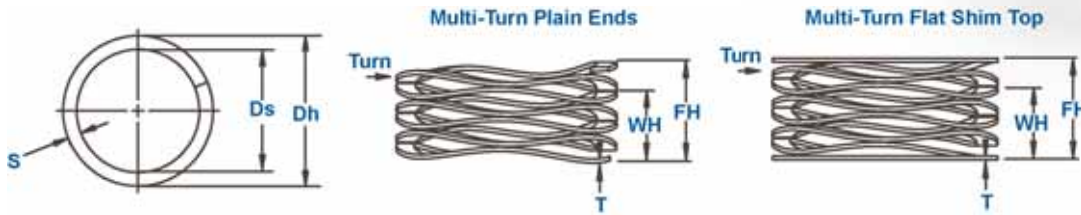

WAVE SPRING NO.	PILOTS & OPERATES IN HOUSING DIAMETER	SHAFT DIAMETER CLEARANCE	LOAD (N)	WORK HEIGHT	FREE HEIGHT Ref.	NUMBER OF WAVES	NUMBER OF TURNS	THICKNESS	SECTION	SPRING RATE Ref.
	Dh mm	Ds		WH	FH			T	s	
MWR-25 A	25	19	110	4.04	6.63	3.5	3	0.38	2.39	42.46
MWR-25 B	25	19	110	5.38	8.84	3.5	4	0.38	2.39	31.84
MWR-25 C	25	19	110	6.73	11.05	3.5	5	0.38	2.39	25.47
MWR-25 D	25	19	110	8.08	13.26	3.5	6	0.38	2.39	21.23
MWR-25 E	25	19	110	9.40	15.47	3.5	7	0.38	2.39	18.12
MWR-25 F	25	19	110	12.12	19.89	3.5	9	0.38	2.39	14.15
MWR-25 G	25	19	110	16.15	26.52	3.5	12	0.38	2.39	10.61
MWL-28 A	28	22	50	3.76	7.24	3.5	3	0.30	2.39	14.37
MWL-28 B	28	22	50	5.00	9.65	3.5	4	0.30	2.39	10.76
MWL-28 C	28	22	50	6.27	12.07	3.5	5	0.30	2.39	8.63
MWL-28 D	28	22	50	7.52	14.48	3.5	6	0.30	2.39	7.18
MWL-28 E	28	22	50	8.79	16.89	3.5	7	0.30	2.39	6.17
MWL-28 F	28	22	50	10.03	19.30	3.5	8	0.30	2.39	5.39
MWL-28 G	28	22	50	11.28	21.72	3.5	9	0.30	2.39	4.79
MWL-28 H	28	22	50	13.79	26.54	3.5	11	0.30	2.39	3.92
MWL-28 I	28	22	50	16.31	31.37	3.5	13	0.30	2.39	3.32
MWM-28 A	28	22	80	4.39	7.24	3.5	3	0.38	2.39	28.12
MWM-28 B	28	22	80	5.84	9.65	3.5	4	0.38	2.39	21.00
MWM-28 C	28	22	80	7.32	12.07	3.5	5	0.38	2.39	16.84
MWM-28 D	28	22	80	8.79	14.48	3.5	6	0.38	2.39	14.06
MWM-28 E	28	22	80	10.24	16.89	3.5	7	0.38	2.39	12.02
MWM-28 F	28	22	80	11.71	19.30	3.5	8	0.38	2.39	10.53
MWM-28 G	28	22	80	13.18	21.72	3.5	9	0.38	2.39	9.37
MWM-28 H	28	22	80	16.10	26.54	3.5	11	0.38	2.39	7.66
MWM-28 I	28	22	80	19.02	31.37	3.5	13	0.38	2.39	6.48
MWR-28 A	28	22	130	4.57	7.24	3.5	3	0.46	2.39	48.74
MWR-28 B	28	22	130	6.07	9.65	3.5	4	0.46	2.39	36.30
MWR-28 C	28	22	130	7.59	12.07	3.5	5	0.46	2.39	29.08
MWR-28 D	28	22	130	9.12	14.48	3.5	6	0.46	2.39	24.26
MWR-28 E	28	22	130	10.64	16.89	3.5	7	0.46	2.39	20.81
MWR-28 F	28	22	130	12.17	19.30	3.5	8	0.46	2.39	18.21
MWR-28 G	28	22	130	13.69	21.72	3.5	9	0.46	2.39	16.20
MWR-28 H	28	22	130	16.71	26.54	3.5	11	0.46	2.39	13.23
MWR-28 I	28	22	130	19.76	31.37	3.5	13	0.46	2.39	11.20

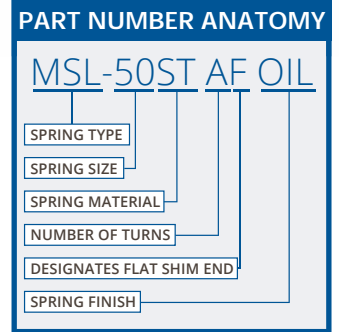

Part numbers shown in the table reflect multi-turn wave springs with plain ends.

The letters shown after the part numbers represent the number of turns.

When ordering, parts should be presented with the part number, followed by the material, and then the number of turns (i.e. MWL-5ST A, MWM-20ST B, MWR-25ST C, etc.)

For flat shim top wave springs, add an 'F' to the end of the part number (i.e. MWL-6ST AF, MWM-20ST BF, MWR-25ST CF, etc.)

Standard Material Codes:

ST = carbon steel.
 SQ = 17-7 PH/C stainless steel.
 Special alloys available upon request.

ALL DIMENSIONS IN MILLIMETERS UNLESS OTHERWISE SPECIFIED.

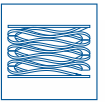

MWL, MWM, MWR WAVE SPRINGS

Multi Turn, Metric

Used for low to medium force applications with greater travel compared to single-turn springs. Utilizes nearly half the space as helical compression springs while producing the same force.

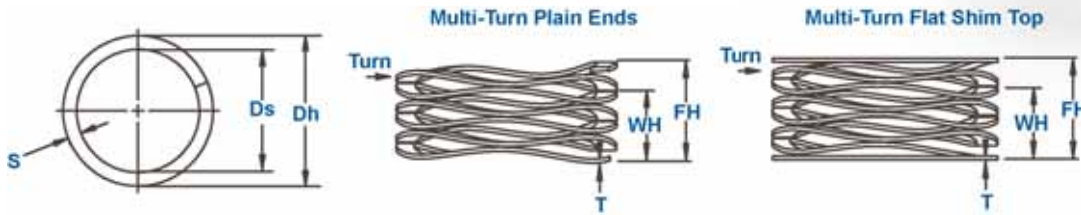

WAVE SPRING NO.	PILOTS & OPERATES IN HOUSING DIAMETER	SHAFT DIAMETER CLEARANCE	LOAD (N)	WORK HEIGHT	FREE HEIGHT Ref.	NUMBER OF WAVES	NUMBER OF TURNS	THICKNESS	SECTION	SPRING RATE Ref.
	Dh mm	Ds		WH	FH			T	s	N/mm
MWL-30 A	30	24	50	3.18	7.62	3.5	3	0.30	2.39	11.25
MWL-30 B	30	24	50	4.22	10.16	3.5	4	0.30	2.39	8.41
MWL-30 C	30	24	50	5.28	12.70	3.5	5	0.30	2.39	6.74
MWL-30 D	30	24	50	6.32	15.24	3.5	6	0.30	2.39	5.61
MWL-30 E	30	24	50	7.39	17.78	3.5	7	0.30	2.39	4.81
MWL-30 F	30	24	50	8.43	20.32	3.5	8	0.30	2.39	4.21
MWL-30 G	30	24	50	9.50	22.86	3.5	9	0.30	2.39	3.74
MWL-30 H	30	24	50	11.61	27.94	3.5	11	0.30	2.39	3.06
MWL-30 I	30	24	50	13.72	33.02	3.5	13	0.30	2.39	2.59
MWM-30 A	30	24	90	3.51	7.62	3.5	3	0.38	2.39	21.87
MWM-30 B	30	24	90	4.70	10.16	3.5	4	0.38	2.39	16.48
MWM-30 C	30	24	90	5.87	12.70	3.5	5	0.38	2.39	13.17
MWM-30 D	30	24	90	7.04	15.24	3.5	6	0.38	2.39	10.97
MWM-30 E	30	24	90	8.20	17.78	3.5	7	0.38	2.39	9.40
MWM-30 F	30	24	90	9.37	20.32	3.5	8	0.38	2.39	8.22
MWM-30 G	30	24	90	10.54	22.86	3.5	9	0.38	2.39	7.31
MWM-30 H	30	24	90	12.90	27.94	3.5	11	0.38	2.39	5.99
MWM-30 I	30	24	90	15.24	33.02	3.5	13	0.38	2.39	5.06
MWR-30 A	30	24	130	4.19	7.62	3.5	3	0.46	2.39	37.91
MWR-30 B	30	24	130	5.59	10.16	3.5	4	0.46	2.39	28.43
MWR-30 C	30	24	130	6.99	12.70	3.5	5	0.46	2.39	22.75
MWR-30 D	30	24	130	8.38	15.24	3.5	6	0.46	2.39	18.96
MWR-30 E	30	24	130	9.78	17.78	3.5	7	0.46	2.39	16.25
MWR-30 F	30	24	130	11.18	20.32	3.5	8	0.46	2.39	14.22
MWR-30 G	30	24	130	12.57	22.86	3.5	9	0.46	2.39	12.64
MWR-30 H	30	24	130	15.37	27.94	3.5	11	0.46	2.39	10.34
MWR-30 I	30	24	130	18.16	33.02	3.5	13	0.46	2.39	8.75
MWL-35 A	35	27	70	3.94	8.38	3.5	3	0.36	3.18	15.75
MWL-35 B	35	27	70	5.23	11.18	3.5	4	0.36	3.18	11.78
MWL-35 C	35	27	70	6.55	13.97	3.5	5	0.36	3.18	9.44
MWL-35 D	35	27	70	7.87	16.76	3.5	6	0.36	3.18	7.87
MWL-35 E	35	27	70	9.17	19.56	3.5	7	0.36	3.18	6.74
MWL-35 F	35	27	70	10.49	22.35	3.5	8	0.36	3.18	5.90
MWL-35 G	35	27	70	11.81	25.15	3.5	9	0.36	3.18	5.25
MWL-35 H	35	27	70	14.43	30.73	3.5	11	0.36	3.18	4.29
MWL-35 I	35	27	70	17.04	36.32	3.5	13	0.36	3.18	3.63

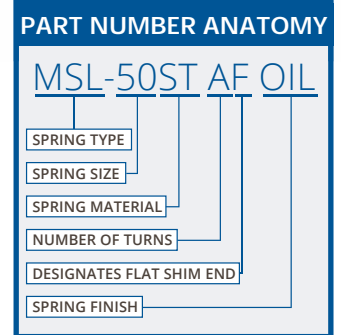

Part numbers shown in the table reflect multi-turn wave springs with plain ends.

The letters shown after the part numbers represent the number of turns.

When ordering, parts should be presented with the part number, followed by the material, and then the number of turns (i.e. MWL-5ST A, MWM-20ST B, MWR-25ST C, etc.)

For flat shim top wave springs, add an 'F' to the end of the part number (i.e. MWL-6ST AF, MWM-20ST BF, MWR-25ST CF, etc.)

Standard Material Codes:

ST = carbon steel.
 SQ = 17-7 PH/C stainless steel.
 Special alloys available upon request.

ALL DIMENSIONS IN MILLIMETERS UNLESS OTHERWISE SPECIFIED.

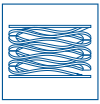

MWL, MWM, MWR WAVE SPRINGS

Multi Turn, Metric

Used for low to medium force applications with greater travel compared to single-turn springs. Utilizes nearly half the space as helical compression springs while producing the same force.

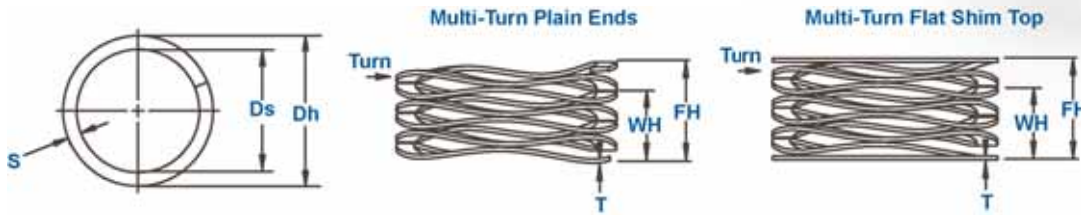

WAVE SPRING NO.	PILOTS & OPERATES IN HOUSING DIAMETER	SHAFT DIAMETER CLEARANCE	LOAD (N)	WORK HEIGHT	FREE HEIGHT Ref.	NUMBER OF WAVES	NUMBER OF TURNS	THICKNESS	SECTION	SPRING RATE Ref. N/mm
	Dh mm	Ds		WH	FH			T	s	
MWM-35 A	35	27	110	4.14	8.38	3.5	3	0.41	3.38	25.93
MWM-35 B	35	27	110	5.51	11.18	3.5	4	0.41	3.38	19.42
MWM-35 C	35	27	110	6.88	13.97	3.5	5	0.41	3.38	15.52
MWM-35 D	35	27	110	8.26	16.76	3.5	6	0.41	3.38	12.93
MWM-35 E	35	27	110	9.63	19.56	3.5	7	0.41	3.38	11.08
MWM-35 F	35	27	110	11.02	22.35	3.5	8	0.41	3.38	9.71
MWM-35 G	35	27	110	12.40	25.15	3.5	9	0.41	3.38	8.63
MWM-35 H	35	27	110	15.14	30.73	3.5	11	0.41	3.38	7.05
MWM-35 I	35	27	110	17.91	36.32	3.5	13	0.41	3.38	5.97
MWR-35 A	35	27	160	4.04	8.38	3.5	3	0.46	3.38	36.84
MWR-35 B	35	27	160	5.38	11.18	3.5	4	0.46	3.38	27.63
MWR-35 C	35	27	160	6.73	13.97	3.5	5	0.46	3.38	22.10
MWR-35 D	35	27	160	8.08	16.76	3.5	6	0.46	3.38	18.42
MWR-35 E	35	27	160	9.42	19.56	3.5	7	0.46	3.38	15.79
MWR-35 F	35	27	160	10.77	22.35	3.5	8	0.46	3.38	13.81
MWR-35 G	35	27	160	12.12	25.15	3.5	9	0.46	3.38	12.28
MWR-35 H	35	27	160	14.81	30.73	3.5	11	0.46	3.38	10.05
MWR-35 I	35	27	160	17.50	36.32	3.5	13	0.46	3.38	8.50
MWL-40 A	40	30	100	2.90	9.14	3.5	3	0.41	3.38	16.00
MWL-40 B	40	30	100	3.86	12.19	3.5	4	0.41	3.38	12.00
MWL-40 C	40	30	100	4.80	15.24	3.5	5	0.41	3.38	9.58
MWL-40 D	40	30	100	5.77	18.29	3.5	6	0.41	3.38	7.99
MWL-40 E	40	30	100	6.73	21.34	3.5	7	0.41	3.38	6.85
MWL-40 F	40	30	100	7.70	24.38	3.5	8	0.41	3.38	5.99
MWL-40 G	40	30	100	8.66	27.43	3.5	9	0.41	3.38	5.33
MWL-40 H	40	30	100	10.59	33.53	3.5	11	0.41	3.38	4.36
MWL-40 I	40	30	100	12.52	39.62	3.5	13	0.41	3.38	3.69
MWM-40 A	40	30	150	5.44	9.14	3.5	3	0.53	3.63	40.45
MWM-40 B	40	30	150	7.24	12.19	3.5	4	0.53	3.63	30.28
MWM-40 C	40	30	150	9.04	15.24	3.5	5	0.53	3.63	24.20
MWM-40 D	40	30	150	10.85	18.29	3.5	6	0.53	3.63	20.16
MWM-40 E	40	30	150	12.65	21.34	3.5	7	0.53	3.63	17.27
MWM-40 F	40	30	150	14.48	24.38	3.5	8	0.53	3.63	15.14
MWM-40 G	40	30	150	16.28	27.43	3.5	9	0.53	3.63	13.45
MWM-40 H	40	30	150	19.89	33.53	3.5	11	0.53	3.63	11.00
MWM-40 I	40	30	150	23.50	39.62	3.5	13	0.53	3.63	9.30

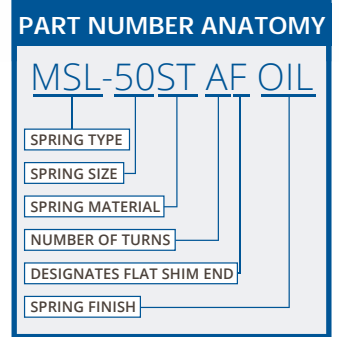

Part numbers shown in the table reflect multi-turn wave springs with plain ends.

The letters shown after the part numbers represent the number of turns.

When ordering, parts should be presented with the part number, followed by the material, and then the number of turns (i.e. MWL-5T A, MWM-20ST B, MWR-25ST C, etc.)

For flat shim top wave springs, add an 'F' to the end of the part number (i.e. MWL-6ST AF, MWM-20ST BF, MWR-25ST CF, etc.)

Standard Material Codes:

ST = carbon steel.
 SQ = 17-7 PH/C stainless steel.
 Special alloys available upon request.

ALL DIMENSIONS IN MILLIMETERS UNLESS OTHERWISE SPECIFIED.

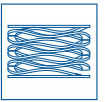

MWL, MWM, MWR WAVE SPRINGS

Multi Turn, Metric

Used for low to medium force applications with greater travel compared to single-turn springs. Utilizes nearly half the space as helical compression springs while producing the same force.

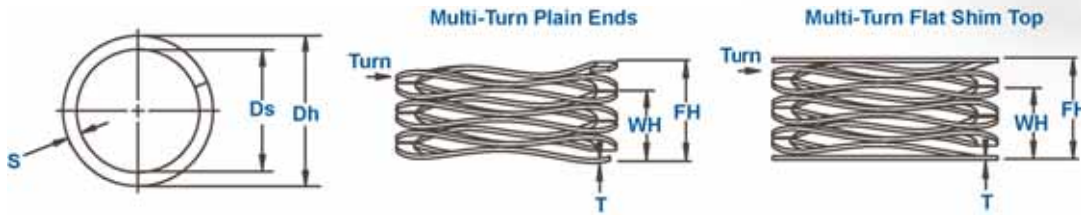

WAVE SPRING NO.	PILOTS & OPERATES IN HOUSING DIAMETER	SHAFT DIAMETER CLEARANCE	LOAD (N)	WORK HEIGHT	FREE HEIGHT Ref.	NUMBER OF WAVES	NUMBER OF TURNS	THICKNESS	SECTION	SPRING RATE Ref.
	Dh mm	Ds		WH	FH			T	s	N/mm
MWR-40 A	40	30	300	5.66	9.14	4.5	3	0.46	3.38	86.21
MWR-40 B	40	30	300	7.54	12.19	4.5	4	0.46	3.38	64.54
MWR-40 C	40	30	300	9.42	15.24	4.5	5	0.46	3.38	51.58
MWR-40 D	40	30	300	11.33	18.29	4.5	6	0.46	3.38	43.11
MWR-40 E	40	30	300	13.21	21.34	4.5	7	0.46	3.38	36.91
MWR-40 F	40	30	300	15.09	24.38	4.5	8	0.46	3.38	32.27
MWR-40 G	40	30	300	16.97	27.43	4.5	9	0.46	3.38	28.67
MWR-40 H	40	30	300	20.75	33.53	4.5	11	0.46	3.38	23.48
MWR-40 I	40	30	300	24.54	39.62	4.5	13	0.46	3.38	19.88
MWL-45 A	45	35	110	3.38	9.91	3.5	3	0.46	3.63	16.85
MWL-45 B	45	35	110	4.52	13.21	3.5	4	0.46	3.63	12.66
MWL-45 C	45	35	110	5.64	16.51	3.5	5	0.46	3.63	10.12
MWL-45 D	45	35	110	6.76	19.81	3.5	6	0.46	3.63	8.43
MWL-45 E	45	35	110	7.90	23.11	3.5	7	0.46	3.63	7.23
MWL-45 F	45	35	110	9.02	26.42	3.5	8	0.46	3.63	6.32
MWL-45 G	45	35	110	10.16	29.72	3.5	9	0.46	3.63	5.62
MWL-45 H	45	35	110	12.40	36.32	3.5	11	0.46	3.63	4.60
MWL-45 I	45	35	110	14.66	42.93	3.5	13	0.46	3.63	3.89
MWM-45 A	45	35	225	5.33	9.91	4.5	3	0.46	3.63	49.21
MWM-45 B	45	35	225	6.99	13.21	4.5	4	0.46	3.63	36.16
MWM-45 C	45	35	225	9.14	16.51	4.5	5	0.46	3.63	30.55
MWM-45 D	45	35	225	10.80	19.81	4.5	6	0.46	3.63	24.95
MWM-45 E	45	35	225	12.70	23.11	4.5	7	0.46	3.63	21.61
MWM-45 F	45	35	225	14.48	26.42	4.5	8	0.46	3.63	18.85
MWM-45 G	45	35	225	16.26	29.72	4.5	9	0.46	3.63	16.71
MWM-45 H	45	35	225	19.81	36.32	4.5	11	0.46	3.63	13.63
MWM-45 I	45	35	225	23.37	42.93	4.5	13	0.46	3.63	11.50
MWR-45 A	45	35	400	6.43	9.91	4.5	3	0.61	3.76	114.95
MWR-45 B	45	35	400	8.38	13.21	4.5	4	0.61	3.76	82.88
MWR-45 C	45	35	400	11.20	16.51	4.5	5	0.61	3.76	75.35
MWR-45 D	45	35	400	12.95	19.81	4.5	6	0.61	3.76	58.33
MWR-45 E	45	35	400	15.37	23.11	4.5	7	0.61	3.76	51.63
MWR-45 F	45	35	400	17.27	26.42	4.5	8	0.61	3.76	43.74
MWR-45 G	45	35	400	19.68	29.72	4.5	9	0.61	3.76	39.87
MWR-45 H	45	35	400	24.26	36.32	4.5	11	0.61	3.76	33.15
MWR-45 I	45	35	400	28.45	42.93	4.5	13	0.61	3.76	27.63

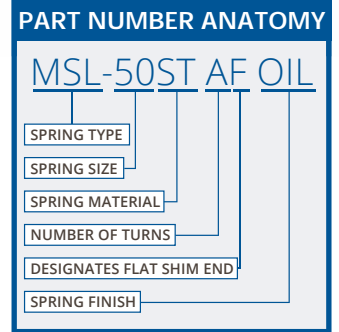

Part numbers shown in the table reflect multi-turn wave springs with plain ends.

The letters shown after the part numbers represent the number of turns.

When ordering, parts should be presented with the part number, followed by the material, and then the number of turns (i.e. MWL-5ST A, MWM-20ST B, MWR-25ST C, etc.)

For flat shim top wave springs, add an 'F' to the end of the part number (i.e. MWL-6ST AF, MWM-20ST BF, MWR-25ST CF, etc.)

Standard Material Codes:

ST = carbon steel.
 SQ = 17-7 PH/C stainless steel.
 Special alloys available upon request.

ALL DIMENSIONS IN MILLIMETERS UNLESS OTHERWISE SPECIFIED.

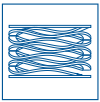

MWL, MWM, MWR WAVE SPRINGS

Multi Turn, Metric

Used for low to medium force applications with greater travel compared to single-turn springs. Utilizes nearly half the space as helical compression springs while producing the same force.

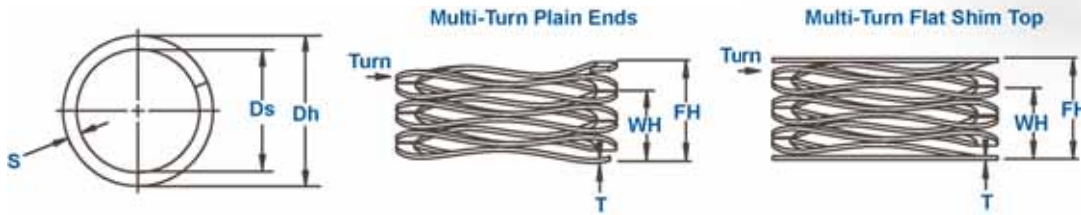

WAVE SPRING NO.	PILOTS & OPERATES IN HOUSING DIAMETER	SHAFT DIAMETER CLEARANCE	LOAD (N)	WORK HEIGHT	FREE HEIGHT Ref.	NUMBER OF WAVES	NUMBER OF TURNS	THICKNESS	SECTION	SPRING RATE Ref.
	Dh mm	Ds		WH	FH			T	s	
MWL-50 A	50	40	110	4.83	10.29	3.5	3	0.53	3.63	20.14
MWL-50 B	50	40	110	6.10	13.72	3.5	4	0.53	3.63	14.44
MWL-50 C	50	40	110	7.87	17.15	3.5	5	0.53	3.63	11.86
MWL-50 D	50	40	110	9.40	20.57	3.5	6	0.53	3.63	9.84
MWL-50 E	50	40	110	11.30	24.00	3.5	7	0.53	3.63	8.66
MWL-50 F	50	40	110	12.70	27.43	3.5	8	0.53	3.63	7.47
MWL-50 G	50	40	110	14.99	30.86	3.5	9	0.53	3.63	6.93
MWL-50 H	50	40	110	18.16	37.72	3.5	11	0.53	3.63	5.62
MWL-50 I	50	40	110	21.34	44.58	3.5	13	0.53	3.63	4.73
MWL-50 J	50	40	110	24.64	51.44	3.5	15	0.53	3.63	4.10
MWM-50 A	50	40	225	4.62	10.29	4.5	3	0.46	3.63	39.72
MWM-50 B	50	40	225	6.35	13.72	4.5	4	0.46	3.63	30.55
MWM-50 C	50	40	225	7.49	17.15	4.5	5	0.46	3.63	23.31
MWM-50 D	50	40	225	8.89	20.57	4.5	6	0.46	3.63	19.26
MWM-50 E	50	40	225	10.54	24.00	4.5	7	0.46	3.63	16.71
MWM-50 F	50	40	225	11.89	27.43	4.5	8	0.46	3.63	14.47
MWM-50 G	50	40	225	13.59	30.86	4.5	9	0.46	3.63	13.03
MWM-50 H	50	40	225	16.71	37.72	4.5	11	0.46	3.63	10.71
MWM-50 I	50	40	225	19.61	44.58	4.5	13	0.46	3.63	9.01
MWM-50 J	50	40	225	22.48	51.44	4.5	15	0.46	3.63	7.77
MWR-50 A	50	40	400	5.92	10.29	4.5	3	0.61	3.76	91.56
MWR-50 B	50	40	400	7.80	13.72	4.5	4	0.61	3.76	67.59
MWR-50 C	50	40	400	10.16	17.15	4.5	5	0.61	3.76	57.27
MWR-50 D	50	40	400	11.79	20.57	4.5	6	0.61	3.76	45.51
MWR-50 E	50	40	400	14.15	24.00	4.5	7	0.61	3.76	40.59
MWR-50 F	50	40	400	15.62	27.43	4.5	8	0.61	3.76	33.87
MWR-50 G	50	40	400	17.91	30.86	4.5	9	0.61	3.76	30.88
MWR-50 H	50	40	400	21.54	37.72	4.5	11	0.61	3.76	24.72
MWR-50 I	50	40	400	25.65	44.58	4.5	13	0.61	3.76	21.14
MWR-50 J	50	40	400	29.21	51.44	4.5	15	0.61	3.76	18.00
MWL-55 A	55	45	125	5.59	11.05	3.5	3	0.61	3.76	22.89
MWL-55 B	55	45	125	7.72	14.73	3.5	4	0.61	3.76	17.83
MWL-55 C	55	45	125	9.68	18.41	3.5	5	0.61	3.76	14.31
MWL-55 D	55	45	125	11.48	22.1	3.5	6	0.61	3.76	11.77
MWL-55 E	55	45	125	13.92	25.78	3.5	7	0.61	3.76	10.54
MWL-55 F	55	45	125	15.52	29.46	3.5	8	0.61	3.76	8.96
MWL-55 G	55	45	125	18.41	33.15	3.5	9	0.61	3.76	8.48
MWL-55 H	55	45	125	21.67	40.51	3.5	11	0.61	3.76	6.63
MWL-55 I	55	45	125	25.65	47.88	3.5	13	0.61	3.76	5.62
MWL-55 J	55	45	125	29.77	55.25	3.5	15	0.61	3.76	4.91
MWM-55 A	55	45	250	3.1	11.05	4.5	3	0.46	3.63	31.45
MWM-55 B	55	45	250	4.11	14.73	4.5	4	0.46	3.63	23.55
MWM-55 C	55	45	250	5.16	18.41	4.5	5	0.46	3.63	18.86
MWM-55 D	55	45	250	6.2	22.1	4.5	6	0.46	3.63	15.72
MWM-55 E	55	45	250	7.21	25.78	4.5	7	0.46	3.63	13.46

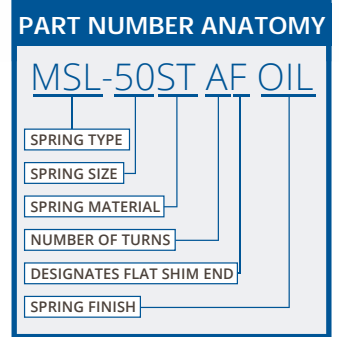

Part numbers shown in the table reflect multi-turn wave springs with plain ends.

The letters shown after the part numbers represent the number of turns.

When ordering, parts should be presented with the part number, followed by the material, and then the number of turns (i.e. MWL-5ST A, MWM-20ST B, MWR-25ST C, etc.)

For flat shim top wave springs, add an 'F' to the end of the part number (i.e. MWL-6ST AF, MWM-20ST BF, MWR-25ST CF, etc.)

Standard Material Codes:

- ST = carbon steel.
- SQ = 17-7 PH/C stainless steel.
- Special alloys available upon request.

ALL DIMENSIONS IN MILLIMETERS UNLESS OTHERWISE SPECIFIED.

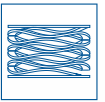

MWL, MWM, MWR WAVE SPRINGS

Multi Turn, Metric

Used for low to medium force applications with greater travel compared to single-turn springs. Utilizes nearly half the space as helical compression springs while producing the same force.

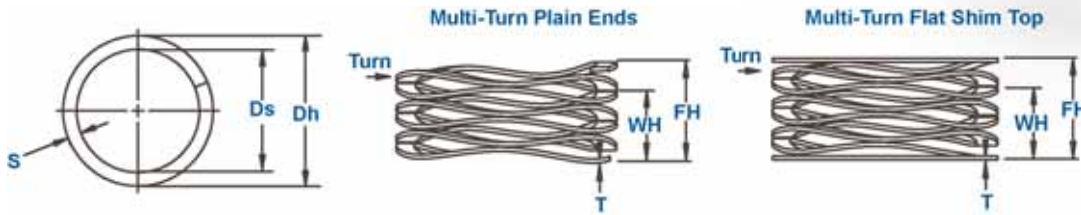

WAVE SPRING NO.	PILOTS & OPERATES IN HOUSING DIAMETER	SHAFT DIAMETER CLEARANCE	LOAD (N)	WORK HEIGHT	FREE HEIGHT Ref.	NUMBER OF WAVES	NUMBER OF TURNS	THICKNESS	SECTION	SPRING RATE Ref.
	Dh mm	Ds		WH	FH			T	s	
MWM-55 F	55	45	250	8.26	29.46	4.5	8	0.46	3.63	11.79
MWM-55 G	55	45	250	9.27	33.15	4.5	9	0.46	3.63	10.47
MWM-55 H	55	45	250	11.33	40.51	4.5	11	0.46	3.63	8.57
MWM-55 I	55	45	250	13.41	47.88	4.5	13	0.46	3.63	7.25
MWM-55 J	55	45	250	15.47	55.25	4.5	15	0.46	3.63	6.29
MWR-55 A	55	45	400	5.31	11.05	4.5	3	0.61	3.76	69.68
MWR-55 B	55	45	400	7.24	14.73	4.5	4	0.61	3.76	53.38
MWR-55 C	55	45	400	9.09	18.41	4.5	5	0.61	3.76	42.91
MWR-55 D	55	45	400	10.64	22.1	4.5	6	0.61	3.76	34.92
MWR-55 E	55	45	400	12.24	25.78	4.5	7	0.61	3.76	29.55
MWR-55 F	55	45	400	14.1	29.46	4.5	8	0.61	3.76	26.03
MWR-55 G	55	45	400	15.82	33.15	4.5	9	0.61	3.76	23.09
MWR-55 H	55	45	400	19.3	40.51	4.5	11	0.61	3.76	18.86
MWR-55 I	55	45	400	23.11	47.88	4.5	13	0.61	3.76	16.15
MWR-55 J	55	45	400	26.54	55.25	4.5	15	0.61	3.76	13.94
MWL-60 A	60	50	135	5.59	11.43	4.5	3	0.46	3.63	23.11
MWL-60 B	60	50	135	7.47	15.24	4.5	4	0.46	3.63	17.37
MWL-60 C	60	50	135	9.32	19.05	4.5	5	0.46	3.63	13.88
MWL-60 D	60	50	135	11.2	22.86	4.5	6	0.46	3.63	11.58
MWL-60 E	60	50	135	13.06	26.67	4.5	7	0.46	3.63	9.92
MWL-60 F	60	50	135	14.94	30.48	4.5	8	0.46	3.63	8.68
MWL-60 G	60	50	135	16.79	34.29	4.5	9	0.46	3.63	7.71
MWL-60 H	60	50	135	20.52	41.91	4.5	11	0.46	3.63	6.31
MWL-60 I	60	50	135	24.26	49.53	4.5	13	0.46	3.63	5.34
MWL-60 J	60	50	135	27.99	57.15	4.5	15	0.46	3.63	4.63
MWM-60 A	60	50	275	6.65	11.43	4.5	3	0.61	3.76	57.59
MWM-60 B	60	50	275	8.86	15.24	4.5	4	0.61	3.76	43.13
MWM-60 C	60	50	275	11.07	19.05	4.5	5	0.61	3.76	34.48
MWM-60 D	60	50	275	13.28	22.86	4.5	6	0.61	3.76	28.72
MWM-60 E	60	50	275	15.49	26.67	4.5	7	0.61	3.76	24.61
MWM-60 F	60	50	275	17.7	30.48	4.5	8	0.61	3.76	21.52
MWM-60 G	60	50	275	19.94	34.29	4.5	9	0.61	3.76	19.16
MWM-60 H	60	50	275	24.36	41.91	4.5	11	0.61	3.76	15.67
MWM-60 I	60	50	275	28.78	49.53	4.5	13	0.61	3.76	13.25
MWM-60 J	60	50	275	33.22	57.15	4.5	15	0.61	3.76	11.49
MWR-60 A	60	50	450	7.75	11.43	4.5	3	0.76	4.01	122.18
MWR-60 B	60	50	450	10.31	15.24	4.5	4	0.76	4.01	91.32
MWR-60 C	60	50	450	12.9	19.05	4.5	5	0.76	4.01	73.21
MWR-60 D	60	50	450	15.47	22.86	4.5	6	0.76	4.01	60.88
MWR-60 E	60	50	450	18.06	26.67	4.5	7	0.76	4.01	52.26
MWR-60 F	60	50	450	20.62	30.48	4.5	8	0.76	4.01	45.66
MWR-60 G	60	50	450	23.22	34.29	4.5	9	0.76	4.01	40.63
MWR-60 H	60	50	450	28.37	41.91	4.5	11	0.76	4.01	33.24
MWR-60 I	60	50	450	33.53	49.53	4.5	13	0.76	4.01	28.12
MWR-60 J	60	50	450	38.68	57.15	4.5	15	0.76	4.01	24.37

PART NUMBER ANATOMY

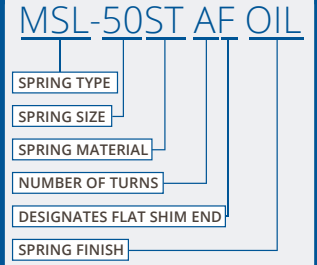

Part numbers shown in the table reflect multi-turn wave springs with plain ends.

The letters shown after the part numbers represent the number of turns.

When ordering, parts should be presented with the part number, followed by the material, and then the number of turns (i.e. MWL-5ST A, MWM-20ST B, MWR-25ST C, etc.)

For flat shim top wave springs, add an 'F' to the end of the part number (i.e. MWL-6ST AF, MWM-20ST BF, MWR-25ST CF, etc.)

Standard Material Codes:

ST = carbon steel.
 SQ = 17-7 PH/C stainless steel.
 Special alloys available upon request.

ALL DIMENSIONS IN MILLIMETERS UNLESS OTHERWISE SPECIFIED.



WAVE SPRING QUOTE & DESIGN FORM

As soon as a standard catalogue item cannot be considered for your application, Rotor Clip can offer custom designed wave springs without expensive tooling costs and with regards to your specification criteria. Please fill out this form and send it to the Rotor Clip engineering department (Fax: +1-732-805-6474, E-Mail: tech@rotorclip.com) which will check a feasible wave spring design with regards to your specifications.

CONTACT INFORMATION		
Name:		Date:
Company:		Department:
Street:		City:
Postal Code / ZIP:		Country:
Phone:	Fax:	Email:

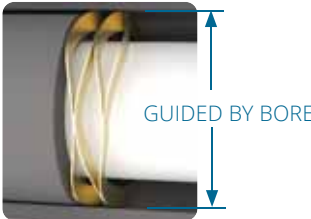
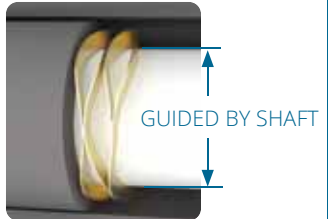
Radial Guide / Pilot	
A multi turn flat wire wave spring has to be guided/piloted radially in order to avoid skipping of the turns. Please indicate a radial guide:	
Bore Diameter: <input type="checkbox"/> [mm] <input type="checkbox"/> [inch]	Shaft Diameter: <input type="checkbox"/> [mm] <input type="checkbox"/> [inch]
<input type="checkbox"/> Pilots and Operates in Bore Diameter <input type="checkbox"/> Pilots Over and Clears Shaft Diameter <input type="checkbox"/> Clings in Bore Diameter* <input type="checkbox"/> Clings on Shaft Diameter <small>*For Single Turn Wave Springs only</small>	 







Load Specifications	
Please define the load(s) required at given work height(s). Values in: <input type="checkbox"/> [N] and [mm] or <input type="checkbox"/> [lbs] and [inch]	
Static Application	Dynamic Application/ Endplay Take-up
_____ at _____ Load (Min. / Max.) Work Height	_____ at _____ Load 1 (Min. / Max.) 1. Work Height
	_____ at _____ Load 2 (Min. / Max.) 2. Work Height
Free Height: <input type="checkbox"/> min. <input type="checkbox"/> max.	

Cycle Life	
Please specify the required cycle life:	
<input type="checkbox"/> Static Application	<input type="checkbox"/> 10 ⁵ Cycles <input type="checkbox"/> > 10 ⁶ Cycles
<input type="checkbox"/> < 10 ⁴ Cycles	<input type="checkbox"/> 10 ⁶ Cycles

Operating Conditions	
Please define under which conditions the wave spring is expected to operate:	
Max. Temperature:	°C / °F
The spring will be in contact with:	



WAVE SPRING QUOTE & DESIGN FORM

Type						
						
One turn with gap	One turn with surface-friendly flat ends	One turn with overlapping ends	One turn round wire with gap	Multiple turns with plain ends	Multiple turns with parallel ends	Multiple Nested Turns
<input type="checkbox"/>	<input type="checkbox"/>	<input type="checkbox"/>	<input type="checkbox"/>	<input type="checkbox"/>	<input type="checkbox"/>	<input type="checkbox"/>

Material (Standard)	
<input type="checkbox"/> Carbon Spring Steel (SAE 1070 – 1090)	<input type="checkbox"/> 17-7PH Condition CH900 Stainless (DIN Material No.: 1.4568)

Special Grades	
<input type="checkbox"/> AISI 302 Stainless (DIN Material No.: 1.4319)	<input type="checkbox"/> Elgiloy (DIN Material No.: 2.4711)
<input type="checkbox"/> AISI 316 Stainless (DIN Material No.: 1.4401)	<input type="checkbox"/> Hastelloy C276 (DIN Material No.: 2.4819)
<input type="checkbox"/> A286 (DIN Material No.: 1.4980)	<input type="checkbox"/> Beryllium-Copper (DIN Material No.: 2.1247)
<input type="checkbox"/> Inconel X-750 (DIN Material No.: 2.4669)	<input type="checkbox"/> Phosphor-Bronze (DIN Material No.: 2.1030)

Finish		
What is the finish requirement of your application:		
<input type="checkbox"/> Oiled (Standard with Carbon Spring Steel)	<input type="checkbox"/> Vibratory Finishing	<input type="checkbox"/> Electropolish
<input type="checkbox"/> Degreased & Ultrasonic-Cleaned (Stainless Steel)	<input type="checkbox"/> Black Oxide	with _____ µm abrasion rate
<input type="checkbox"/> Passivation	<input type="checkbox"/> Deburred	<input type="checkbox"/> Other: _____

Volume	Delivery Time
Prototype Volume:	Prototype:
Series Volume:	Series:

Description of Application / Sketch

ROTOR CLIP®

U.S.A. WORLD HEADQUARTERS

187 Davidson Avenue
Somerset, NJ 08873
USA
+1 732-469-7333
Fax: +1 732-469-7898
E-mail: info@rotorclip.com

CZECH REPUBLIC

Pražská 403, CZ-411 18
Budyně nad Ohří
Czech Republic
+420 416 863 168
Fax: +420 416 863 193
E-mail: rotorclipcz@rotorclip.com

UNITED KINGDOM

Unit 6, Meadowbrook Park, Holbrook,
Sheffield, S20 3PJ
United Kingdom
+44 (0) 114 247 3399
Fax: +44 (0) 114 247 4499
E-mail: rcltd@rotorclip.com

GERMANY

TRUWAVE Germany GmbH
Buchwiese 3, D-65510 Idstein/Taunus
Germany
+49 (0) 6126 227360
Fax: +49 (0) 6126 2273619
E-mail: rcg@rotorclip.com

PEOPLE'S REPUBLIC OF CHINA

1F, Building 8, No. 1299, Songying Road
Qingpu District, Shanghai, China 201706
+86 21 31155558
Fax: +86 21 31155556
E-mail: china@rotorclip.com

WWW.ROTORCLIP.COM