

A layman's guide (and a refresher for the expert) to retaining rings
... how they work ... what they are made of ... and MORE!



**THE
ULTIMATE
RETAINING RING GUIDE**



by
® ROTOR CLIP COMPANY, INC.

TABLE OF CONTENTS

What Is a Retaining Ring?	1
Axial Retaining Rings	3
Internal, HO	4
External, SH	6
Inverted, HOI (Internal)	8
Inverted, SHI (External)	9
Internal/Bowed, BHO	10
External/Bowed, BSH	11
Beveled, VHO (Internal), VSH (External)	12
Reinforced, External, SHR	13
Tamper-proof, External, SHM	13
Assembly Tools	14
Summary	15
Radial Retaining Rings	17
External, E	18
Reinforced, External, RE	20
Bowed, External, BE	21
External, Crescent, C	22
Interlocking, External, LC	23
External Poodle Rings, PO/POL	24
External Locking, EL	25
Assembly Tools	26
Summary	28
Self-Locking Retaining Rings	30
Shaft Friction, SHF	30
Toothed External, TX / TY	32
Toothed Internal, TI	33
Radial Grip, External, RG	3
4	
Assembly Tools	35
Summary	36
Materials, Finishes & Packaging	37
Materials	37
Finishes	38
Packaging	40
Breaking the Code	41
Design Considerations	45
Automated Assembly / Axial Rings	54
Identifying Retaining Rings	57
How to Use a Caliper	61
How to Use a Micrometer	62
The Rotor Files	63
Rotor Clip Literature	66
Rotor Clip Online	67
Constant Section Ring Program	68
Rotor Clamp - Self-Compensating Hose Clamps	69

What Is a Retaining Ring?

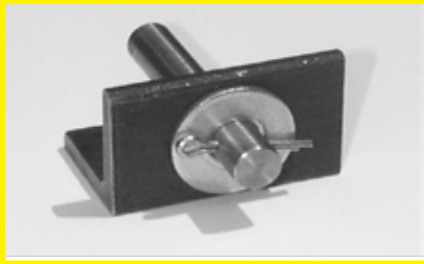

Traditional method of fastening.

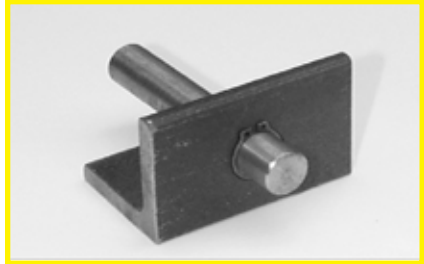

Cost-saving method offered by Rotor Clip.

The traditional method for fastening components and assemblies in housings and on shafts usually involves some type of shaft/housing preparation and multiple components to accomplish the fastening task. Note the example above. You could hold the shaft to the brace by drilling a hole through it, installing a washer and fastening the system with a cotter pin.

It may seem simple, but in today's cost-cutting, global environment, greater savings are available than offered by this traditional method.

Take another look at the same example. Instead of drilling a hole and using two components to complete the assembly, you could simply machine a groove onto the shaft and install an external retaining ring. The same fastening task is accomplished with one component instead of two, with less shaft preparation.



What is a Retaining Ring?

That's what retaining rings do: fasten assemblies on shafts or in housing/bores. They are installed into a groove creating a shoulder that retains the assembly. Retaining rings are more efficient and cost-effective than traditional fasteners like screws, nuts, bolts, cotter pins, washers and more. And they do it with a minimum amount of surface preparation to either shaft or housing.

This guide will help you understand the different types of retaining rings and the function of each. The differences are subtle, but important. Understanding what type of retaining ring to use in a particular application could result in enormous savings in time and costs on your next fastener project.

We welcome your questions as well as your comments on this guide. Contact Rotor Clip Company at 1-800-557-6867, 732-469-7333, Fax 732-469-7898, or email: adv@rotorclip.com

**ROTOR CLIP:
Innovation Every Day.**

Axial Retaining Rings



Axial RotorClips® retain assemblies on shafts and in housings and bores.

Inch: HO, SH, HOI, SHI, BHO, VHO, BSH, VSH, SHR, SHM;
DIN Metric: DHO, DSH, DHI, DHT, DSI, DST, DHR, DSR;
ANSI Metric: MHO, MSH, MSR

1. Internal housing/external shaft retaining rings.
2. Feature lugs and lug holes used to install/remove the rings (except for the SHM ring).
3. Make almost complete circular contact with the groove enabling them to withstand significant thrust loadings.
4. Made to World Standards —Inch, DIN (Metric), ANSI Metric, JIS.
5. Installed in an axial (horizontal) direction in a housing/bore or on a shaft.

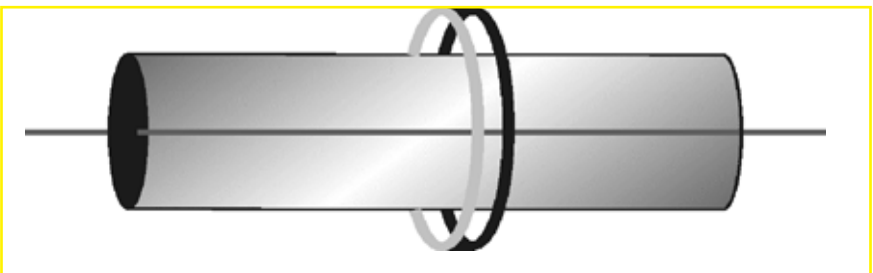

AXIAL Retaining Rings

Internal, HO



Without anything to stop it, this coin will pass through this housing and out the other end.

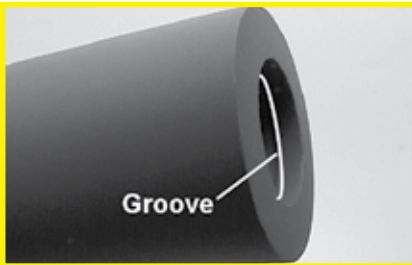

By machining a groove into the housing...

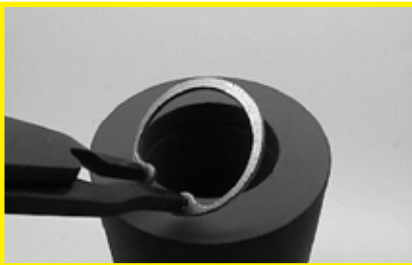

...and installing an HO ("Housing") internal retaining ring into it...



..the coin is stopped before it can fall out.

AXIAL Retaining Rings

Internal, HO

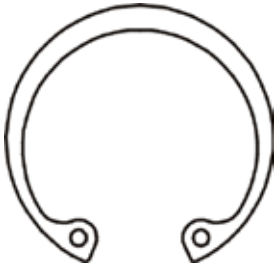

HO stands for “Housing” ring since it is applied internally into a housing or bore.



An HO ring is installed by drawing the lugs together using a special plier with tips on the end.



The ring is then released into a groove. The resulting shoulder of the ring retains a component or assembly.

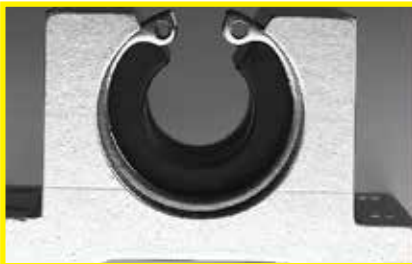

This Rotor Clip HO ring retains a linear bearing within a housing.

***HO rings fit housings/bores from .250 inches to 10 inches in diameter.
DHO rings fit metric housings from 8mm to 400 mm in diameter.
MHO rings fit ANSI metric housings from 8mm to 50mm in diameter.***

AXIAL Retaining Rings

External, SH



Without anything to hold it in place, this gear will eventually “walk” off.

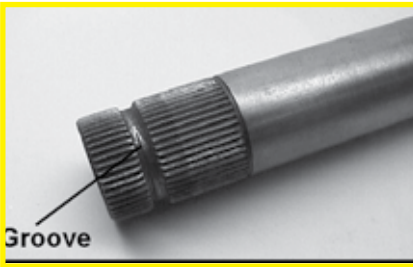

By machining a groove onto the shaft...



...And installing an SH (“shaft”) external circlip (retaining ring) onto it...



...The gear is stopped before it can fall off.

AXIAL Retaining Rings

External, SH



SH stands for “Shaft” ring since it is applied externally onto a shaft.



An SH ring is installed by separating the lugs using a special plier with tips on the end.



The ring is then released into a groove. The resulting shoulder of the ring retains a component or assembly.



A Rotor Clip SH ring retains a gear in a transmission.

SH rings fit shafts from .125 inches to 10 inches in diameter.

DSH rings fit shafts from 3mm to 400mm in diameter.

MSH rings fit ANSI metric shafts from 4mm to 50mm in diameter.

AXIAL Retaining Rings

Inverted, Internal, HOI

HOI - WHEN CLEARANCE IS A PROBLEM



Sometimes the lugs of the standard HO can interfere with the functioning of an application. Consider the example below:

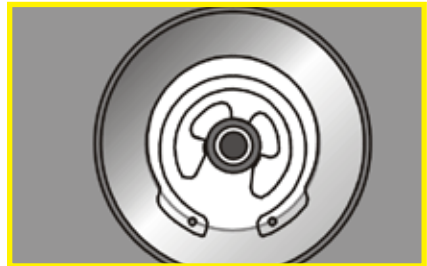

Let's take a look at our housing once again. This time, we have an application that requires an E ring to retain a component on this transmission spool valve and an HO ring to retain another component. As you can see, the lugs of the HO interfere with the E ring.

Time for a different fastener? Not at all. The lugs of the rings can be reversed to form another internal ring called an HOI (the "I" stands for "inverted"). With the HOI installed in the groove, our E ring is now free to spin without any interference from the lugs.

***HOI rings fit housings/bores from .625 inches to 4 inches in diameter.
DHI rings fit housings/bores from 12mm to 100mm in diameter.***

AXIAL Retaining Rings

Inverted, External, SHI

SHI - WHEN CLEARANCE IS A PROBLEM

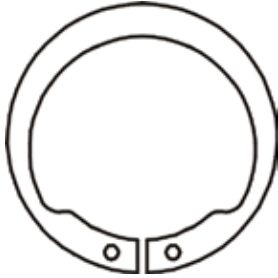

Similarly, the lugs of the standard SH ring can interfere with the functioning of an application. Consider the example below:

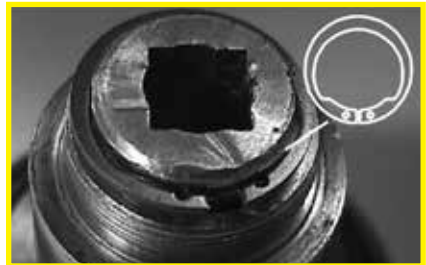

This SH ring is holding in place the threaded portion of this doorknob. But this piece can not be threaded into the knob's base because the lugs are in the way.

By using an SHI the lugs are reversed and do not interfere with the threads.



*SHI rings fit shafts from .500 inches to 3.938 inches in diameter.
DSI rings fit shafts from 12 mm to 100mm in diameter.*

AXIAL Retaining Rings

Bowed, Internal, BHO



**BHO-
Bowed HO Retaining Ring.**

TAKE OUT THE SHAKES, RATTLES AND ROLLS

Remember when cars used to creak and rattle in response to every bump? In some instances, this was due to components on shafts and in housings on the car that were "loose," exhibiting a characteristic known as "end-play."

Endplay occurs when components on a shaft or in a housing are made to tolerances; that is, plus or minus dimensions (see explanation on the following page).

If you want a noise and/or rattle free assembly, you've got to find a way to take up this end-play.

Enter Rotor Clip Bowed and Beveled retaining rings. The bowed BHO/BSH rings are curved and exert a pre-load on the assembly when installed in the groove. This takes up the end-play and acts like a spring, which keeps the assembly in compression. Because there is some movement in the assembly, we refer to this as resilient endplay take up.

***BHO rings fit housings/bores from .250 inches to 1.750 inches in diameter.
BSH rings fit shafts from .250 inches to 1.750 inches in diameter.***

AXIAL Retaining Rings

Bowed, External, BSH

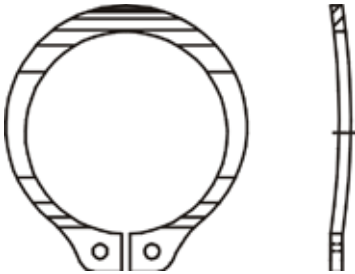

**BSH-
Bowed SH Retaining Ring.**

WHAT ARE ACCUMULATED TOLERANCES?

What are "accumulated tolerances?" In manufacturing, parts can not be produced to an exact dimension. For example, a part that must be .500" thick, may be produced at a tolerance of $+.001"/-.001"$. The "plus" and "minus" dimensions are tolerances, and simply mean that parts produced on the "high side" (.501") or on the "low side" (.499") are acceptable. So a series of parts that you must hold onto a shaft or in a housing will add up to slightly more or slightly less than the target dimension. As a result, if they are made on the low side of the tolerance, they will be loose or have play on the shaft when a standard ring is installed. If they are made on the high side of the tolerance, they will extend further into the groove and prevent a standard ring from being fully installed. Compensating for accumulated tolerances is what our BHO/BSH "Bowed" retaining rings are designed to do, by acting like a spring once installed into the groove.

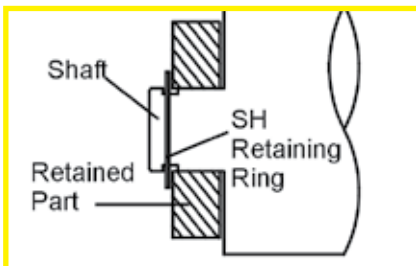

This component was originally held in place by a regular SH retaining ring. But there was "play" in the assembly, since the parts were made on the "low side" of the tolerances.

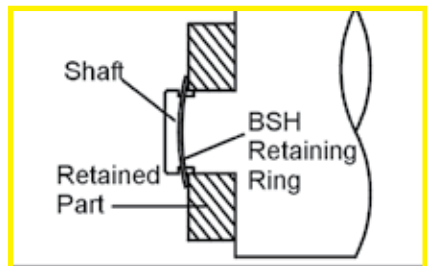

The manufacturer switched to the bowed SH (BSH) ring. The curved shape of the ring compensated for the slightly undersized pieces and held the components tightly in place.

AXIAL Retaining Rings

Internal VHO, External VSH

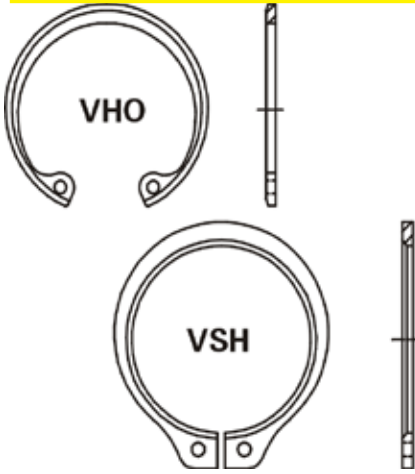

Our “beveled” HO (VHO) and “beveled” SH (VSH) rings look exactly like their HO and SH counterparts, only they feature a 15 degree beveled or angled edge. This angle allows the ring to wedge itself between the groove and the retained part until it can go no further, effectively “locking” everything in place.

For applications in which end-play must be rigid, specify Rotor Clip VHO/VSH retaining rings. These rings wedge themselves between the retained part and the groove wall, until the assembly is virtually “locked” into place. Think of placing a cork in a bottle. The cork is forced into the opening until it is wedged as far into the opening as possible.



The same thing happens when a beveled HO (VHO) retaining ring is installed in this application. The ring is wedging itself into place between the groove wall on the left and the retained part on the right, resulting in what is referred to as rigid end-play takeup.

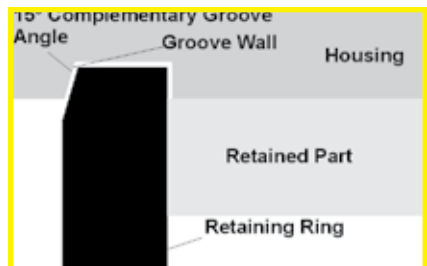

VHO rings fit housings/bores from 1 inch to 10 inches in diameter.

VSH rings fit shafts from 1 inch to 10 inches in diameter.

See pages 63-65 for formulas pertaining to beveled retaining rings.

AXIAL Retaining Rings Reinforced, External, SHR



The SHR is an extra thick version of an external SH (shaft) ring. (The designation stands for SH-shaft R-Reinforced.) As such, it is stronger and can withstand greater thrust loads than its standard counterpart.

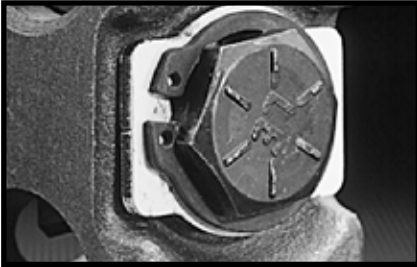

This plate and bolt on this device connect the threads on an A1 Army tank. The SHR Retaining Ring prevents the bolt from loosening and derailing the thread.

SHR rings fit shafts from .394 inches to 2 inches in diameter.

DSR rings fit shafts from 12mm to 100 mm in diameter.

AXIAL Retaining Rings Tamperproof, External, SHM

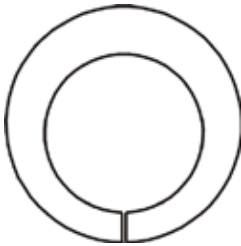

The last ring the axial group is the SHM (SHaft, Miniature). This also functions like an SH ring, but in “smaller” applications. It is also a tamper-proof ring, which can not be removed once installed, since it does not have lugs.

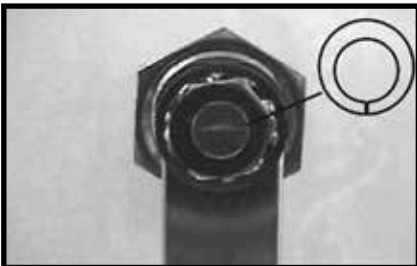

SHM retaining ring retains a lock in a retail table top display.

SHM rings fit shafts from .101 inches to .375 inches

AXIAL Retaining Rings Assembly Tools

All axial retaining rings (except for the SHM) feature lug holes. These are used to install the rings using special pliers with tips that can be inserted into the holes. The lugs then can be compressed (internal) for installation into a housing, expanded (external) for installing over a shaft.

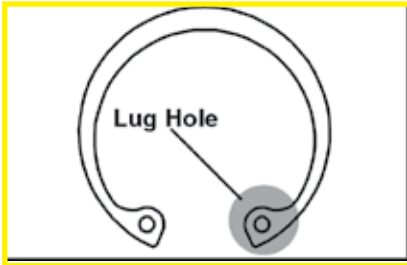

Lug Hole

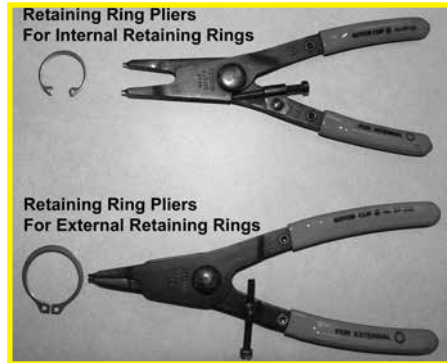

Installation of ROTOR CLIP SHM Rings

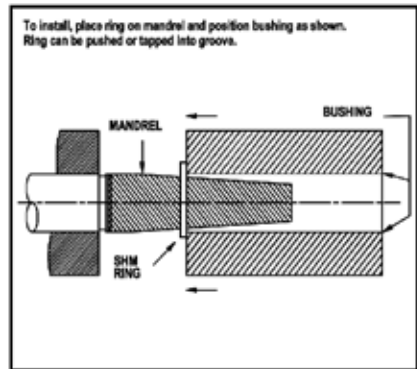
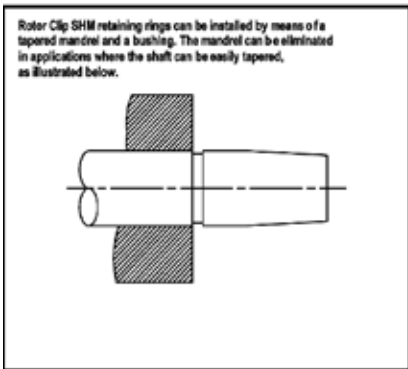

AXIAL Retaining Rings

Summary

The rings in this section are referred to as axial. They have the following characteristics:

1. Installed axially along the center point of an axis (in a horizontal direction).
2. Feature lugs and lug holes used to install/remove the rings (except for the SHM ring).
3. Make almost complete circular contact with the groove enabling them to withstand significant thrust loadings.
4. Made to World Standards—Inch, DIN (Metric), ANSI Metric, JIS



Designation: HO

Type: Internal (housings & bores)

Size Range: .250-10.0 inches (6.4-254.0 mm)

Description: Internal HOusing ring. Once installed in the groove of a housing/bore, the portion of the ring protruding from the groove (also called a "shoulder") holds an assembly in place.



Designation: SH

Type: External (basic shafts & pins)

Size Range: .125-10.0 inches (3.2-254.0 mm)

Description: External SHaft ring. Once installed in the groove of a shaft, the portion of the ring protruding from the groove (also called a "shoulder") holds an assembly in place.



Designation: HOI

Type: Internal, Inverted (housings & bores)

Size Range: .450-4 inches (15.9-101.6 mm)

Description: Internal HOusing Inverted ring. Functions like an HO ring in a housing/bore, only the lugs are "reversed." This version reduces the distance the lugs of the standard HO extend into the inner circumference of the housing/bore and allows for another assembly to pass through unimpeded.



Designation: SHI

Type: External, Inverted (shafts & pins)

Size Range: .500-3.98 inches (12.7-100 mm)

Description: External SHaft Inverted ring. Functions like an SH ring on a shaft, only the lugs are "reversed." This version reduces the distance the lugs of the standard SH extend beyond the circumference of the shaft. The shaft can then be used in an application where clearance is minimal.

AXIAL Retaining Rings Summary



Designation: SHR

Type: External, Heavy Duty (shafts & pins)

Size Range: .394-2.0 inches (10.0-50.8 mm)

Description: External SHaft Reinforced ring. The SHR is an extra thick version of a regular SH retaining ring. As such, it is stronger and can withstand greater thrust loads than its standard counterpart.



Designation: SHM

Type: External, Extra-Strength (shafts & pins)

Size Range: .101-.375 inches (2.6-9.5 mm)

Description: External SHaft Miniature ring. This ring does not have any lugs making it tamper proof once installed.



Designation: BHO

Type: Internal, Bowed (housings & bores)

Size Range: .250-1.750 inches (6.4-44.4 mm)

Description: Internal HOusing ring. Compensating for accumulated tolerances is what a BHO retaining ring is designed to do in a housing/bore. Once snapped into the groove, bowed rings exert a force or a "pre-load" on the retained parts for the range specified in the catalog.



Designation: BSH

Type: External, Bowed (shafts & pins)

Size Range: .250-1.750 inches (4.8-44.4 mm)

Description: External Bowed SHaft ring. Compensating for accumulated tolerances is what a BSH "Bowed" retaining ring is designed to do on a shaft. Once snapped into the groove, bowed rings exert a force or a "pre-load" on the retained parts for the range specified in the catalog.



Designation: VSH

Type: External, Beveled (shafts & pins)

Size Range: 1.0-10.0 inches (25.4-254.0 mm)

Description: External Beveled (V) SHaft ring. These rings look exactly like their SH counterpart, only they have a 15° angle on the inner edge. This combines with a complementary groove angle to eliminate end play by wedging itself between the groove and the retained part.



Designation: VHO

Type: Internal, Beveled (housings & bores)

Size Range: 1.000-10.0 inches (25.4-254.0 mm)

Description: Internal Beveled (V) HOusing ring. These rings look exactly like their HO counterpart, only they have a 15° angle on the outer edge. This combines with a complementary groove angle to eliminate end play by wedging itself between the groove and the retained part.

RADIAL Retaining Rings



Radial Retaining Rings-

Inch: RE-E-C-LC-PO-POL;
DIN Metric: DE-DC;
ANSI Metric: ME-MRE-MC

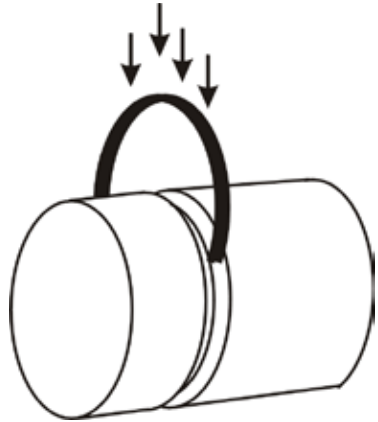

1. External shaft retaining rings.
2. Designed for applications characterized by low thrust loadings.
3. They don't have lugs or lug holes.
4. They do not extend as far around the circumference of the groove as their axial counterparts, thus they accommodate less force.
5. ALL ROTOR CLIP RADIAL RETAINING RINGS ARE EXTERNAL (MADE TO BE APPLIED TO A SHAFT).
6. Made to World Standards— Inch, DIN (Metric), ANSI Metric, JIS.
7. Installed in a radial (vertical) direction on a shaft.

RADIAL Retaining Rings

External, E



Without anything to hold it in place, the cutters of this paper shredder will eventually “walk” off the shaft.

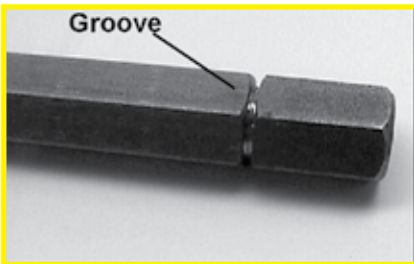

By machining a groove onto the shaft...



...And installing an E (“shaft”) external retaining ring onto it...

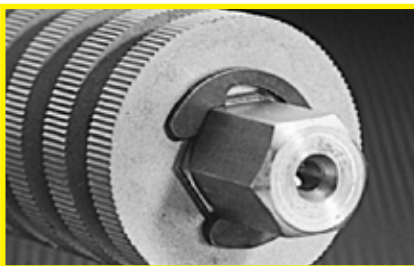

The cutter is stopped by the shoulder of the E ring before it can fall off.

RADIAL Retaining Rings

External, E

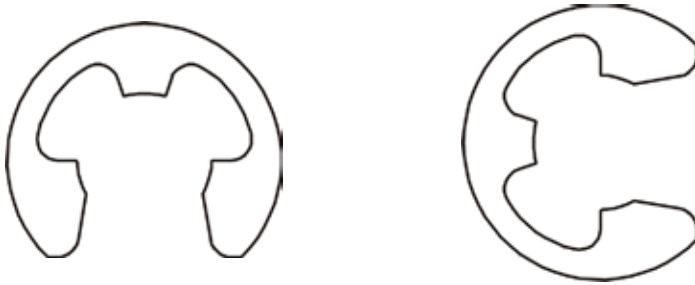

External E ring. Perhaps the most popular and widely used radial retaining ring is the "E" (so named because it is shaped like the letter "E"). The three prongs make contact with the bottom of the groove and provide a shoulder for effective retention of assemblies.

E rings fit shafts from .040 inches to 1.375 inches in diameter.

DE rings fit shafts from 0.8mm to 30mm in diameter.

ME rings fit shafts from 1mm to 25mm in diameter.

JE rings fit shafts from 1mm to 25mm in diameter.



ROTOR CLIP®

RADIAL Retaining Rings

Reinforced, External, RE



The RE retaining ring is a Reinforced version of the E ring which will accommodate higher RPM limits. RE rings function in the same size grooves as regular E rings, so that you can change from one to the other without re-engineering the application.



RE ring provides shoulder to hold protective sleeve in place.

***RE rings fit shafts from .094 inches to .562 inches in diameter.
MRE rings fit shafts from 4mm to 15mm in diameter.***

RADIAL Retaining Rings

Bowed, External, BE

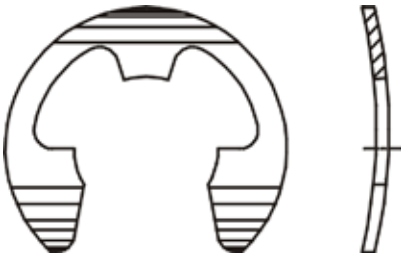

One other important variation of radial retaining rings is the bowed "E", so named because it is shaped like a bow and it is used to compensate for accumulated tolerances.

ACCUMULATED TOLERANCES

What are "accumulated tolerances?" In manufacturing, parts can not be produced to an exact dimension. For example, a part that must be .500" thick, may be produced at a tolerance of $+.001"/-.001"$. The "plus" and "minus" dimensions are tolerances, and simply mean that parts produced on the "high side" (.501") or on the "low side" (.499") are acceptable. So a series of parts that you must hold onto a shaft or in a housing will add up to slightly more or slightly less than the target dimension. As a result, if they are made on the low side of the tolerance, they will be loose or have play on the shaft when a standard ring is installed. If they are made on the high side of the tolerance, they will extend further into the groove and prevent a standard ring from being fully installed. Compensating for accumulated tolerances is what our BE "Bowed" retaining rings are designed to do, by acting like a spring once installed into the groove.

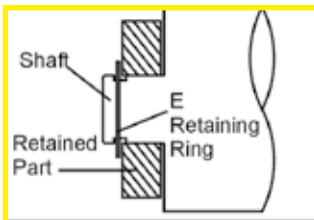

This component was originally held in place by a regular E retaining ring. But there was "play" in the assembly, since the parts were made on the "low side" of the tolerances.

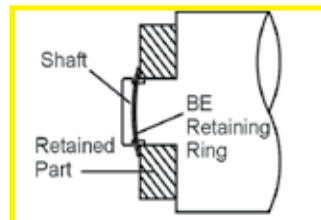

The manufacturer switched to the bowed E (BE) ring. The curved shape of the ring compensated for the slightly undersized pieces and held the components tightly in place.

RADIAL Retaining Rings

External, C



External Crescent ring. Ideal for low clearance applications where radial installation is preferred.

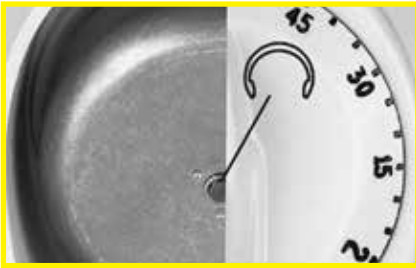

C ring holds timer bell in place.



*C rings fit shafts from .125 inches to 2 inches.
DC rings fit shafts from 3mm to 55mm in diameter.*



RADIAL Retaining Rings

Interlocking, External, LC

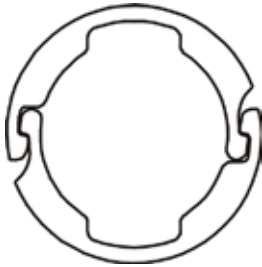

External InterLocking C ring. The LC ring is produced in two identical halves. The ends interlock into a groove on a shaft and, once assembled, are dynamically balanced. As a result, they are particularly effective at retaining assemblies with extremely high rotational speeds.



Two part, LC ring is dynamically balanced once installed, making it very effective in retaining this escalator assembly during high rotational speeds.

LC rings fit shafts from .469 inches to 3.375 inches in diameter.

RADIAL Retaining Rings

External, PO / POL



External POodle Ring/
External POodle Light Ring.
The PO ring features wide "ears" (resembling those of a poodle dog, thus the name) which offer extra retention surface against the retained part. PO rings also come in thinner sizes as a standard series of rings known as POL.

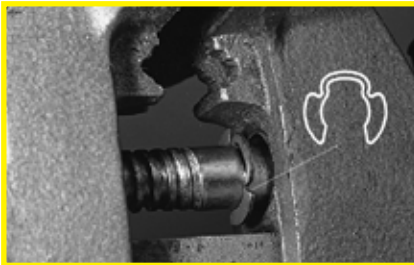

Application of PO "Poodle" retaining ring.

PO rings fit shafts from .156 inches to 2 inches in diameter.

POL rings (the thinner series) fit shafts from .156 inches to 1 inch in diameter.

RADIAL Retaining Rings

External,EL



External E Locking ring. Another variation of a bowed E ring is the EL. In addition to the bowed design for eliminating "play" in an assembly, it also features two prongs which extend from the inner circumference to the open end locking the ring firmly in the groove.

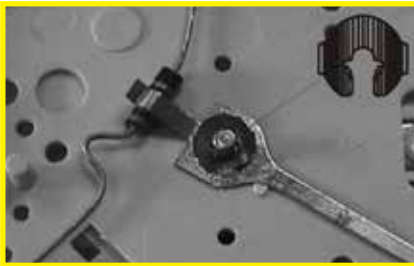

EL Retaining Ring retains element on a thermostat.

EL rings fit shafts from .125-.312 inches in diameter.

RADIAL Retaining Rings

Assembly Tools

Unlike Rotor Clip axial retaining rings, radial rings do not have lug holes and, therefore, can not be installed using retaining ring pliers. Instead, installation is accomplished using special tools known as applicators and dispensers. In order to utilize these tools, radial rings should be ordered stacked, meaning the rings are automatically placed on top of one another and taped in that position.

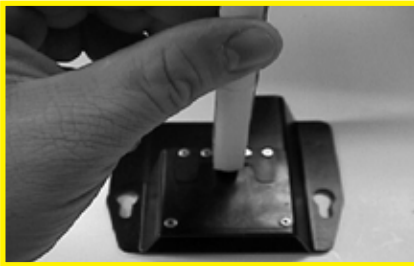

1. Slip the stacked cartridge on the rail of a Rotor Clip Spring Rail (SD) dispenser.

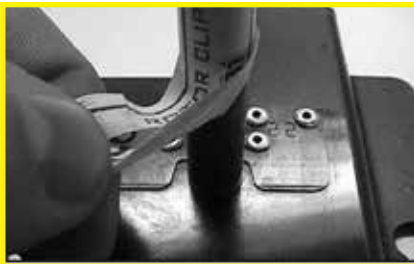

2. Remove the tape. For best results remove tape from the bottom 1-2 inches at a time.



3. Place the Rotor Clip Applicator against the dispenser base groove of tool down and part number facing up.

RADIAL Retaining Rings Assembly Tools



4. Push the applicator into the stack and engage the bottom ring into the groove of the tool.



5. Install the ring in your application. Make sure ring is fully seated in the groove.

The above procedure can be automated using the applicator blade. Before you design and build such equipment, Contact Rotor Clip Technical Sales for more information:

Call Toll-Free: 1-800-557-6867

or

732-469-7333

or

e-mail: tech@rotorclip.com

RADIAL Retaining Rings Summary

External shaft retaining rings.

1. Designed for applications characterized by low thrust loadings.
2. They don't have lugs or lug holes.
3. They do not extend as far around the circumference of the groove as their axial counterparts, thus they accommodate less force.
4. ALL ROTOR CLIP RADIAL RETAINING RINGS ARE EXTERNAL (MADE TO BE APPLIED TO A SHAFT).
5. Made to World Standards—Inch, DIN (Metric), ANSI Metric, JIS
Installed in a radial (vertical) direction on a shaft.



Designation: E

Type: External (shafts & pins)

Size Range: .040-1.375 inches (3.2-34.9 mm)

Description: External E ring. Perhaps the most popular and widely used radial retaining ring is the "E" (so named because it is shaped like the letter "E"). The three prongs make contact with the bottom of the groove and provide a shoulder for effective retention of assemblies.



Designation: RE

Type: External, Reinforced E (shafts & pins)

Size Range: .094-.562 inches (2.4-14.3 mm)

Description: External Reinforced E ring. The RE retaining ring is a Reinforced version of the E ring which will accommodate higher RPM limits. RE rings function in the same size grooves as regular E rings, so that you can change from one to the other without re-engineering the application.



Designation: BE

Type: External, Bowed (shafts)

Size Range: .110-.984 Inches

Description: External Bowed E ring. Compensating for accumulated tolerances is what a BE "Bowed" retaining ring is designed to do on a shaft. Once snapped into the groove, bowed rings exert a force or a "preload" on the retained parts for the range specified in the catalog.



Designation: C

Type: External (shafts & pins)

Size Range: .125-2.0 inches (3.2-50.8mm)

Description: External Crescent ring. Ideal for low clearance applications where radial installation is preferred.

RADIAL Retaining Rings Summary



Designation: LC

Type: External, Interlocking (shafts & pins)

Size Range: .469-3.375 inches (11.9-85.7 mm)

Description: External InterLocking C ring. The LC ring is produced in two identical halves. The ends interlock into a groove on a shaft and, once assembled, are dynamically balanced. As a result, they are particularly effective at retaining assemblies with extremely high rotational speeds.



Designation: PO, POL

Type: External (shafts & pins)

Size Range: PO-.156-2.000 inches (4.0mm-50.8mm)

POL: .156-1.000 inches (4.0mm-25.4mm)

Description: External POodle Ring/ External POodle Light Ring. The PO ring features wide "ears" (resembling those of a poodle, thus the name) which offer extra retention surface against the retained part. PO rings also come in thinner sizes as a standard series of rings known as POL.



Designation: EL

Type: External, Bowed E (shafts & pins)

Size Range: .125-.312 inches (3.2-7.9 mm)

Description: External E Locking ring. Another variation of a bowed E ring is the EL. In addition to the bowed design for eliminating "play" in an assembly, it also features two prongs which extend from the inner circumference to the open end locking the ring firmly in the groove.



Self-Locking Retaining Rings

Inch: SHF, TX/TY, TI, RG; DIN Metric: DTX, DTI

The retaining rings in this section can be installed on a shaft or in a housing/bore without using a groove. For this reason, they are called self-locking with the following advantages:

1. They save machining time and overall costs since a groove is not needed for installation.
2. They come in small sizes (some fitting shafts as small as .058" in diameter) and can be used effectively and economically on small applications with very low thrust loadings.
3. Most are permanent once installed and can not be easily removed.
4. Made to World Standards—Inch, DIN (Metric).

Self-Locking Retaining Rings External, SHF



External SHaft Friction ring. The SHF ring resembles a regular SH ring except that it is designed to function on a shaft without a groove. The design of the ring causes it to exert significant gripping power uniformly on the shaft (except where the gap occurs).

Self-Locking Retaining Rings

External, SHF

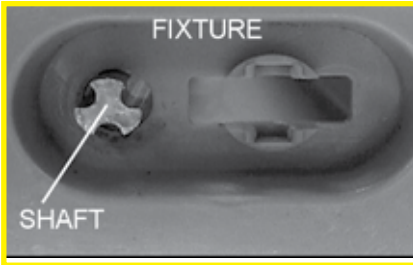

Without anything to hold it in place, the shaft will eventually “walk” out of the fixture.

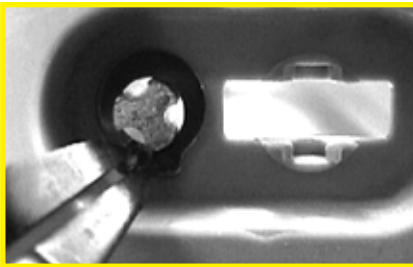

Since this particular application does not exert a great amount of force, an SHF retaining ring is a good choice. It does not require a groove and once installed...



...Will hold the shaft in place on this window blind assembly.

SHF rings fit shafts from .058 inches to .750 inches in diameter.

Self-Locking Retaining Rings

External, TX / TY

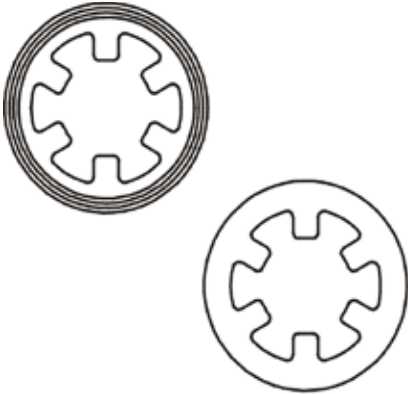

Toothed eXternal "Push on" ring/ Toothed External Y (next in series after X) "Push on" ring. This ring features an outer rim with a series of prongs protruding into the center. The ends create interference with the shaft when the ring is installed and a load introduced to the other side. The difference between these two rings is that the outer rim of the TX is curved while the rim of the TY is flat. The curved rim of the TX affords greater thrust load capacity than the TY and is easier to orient for assembly.



TX ring installed on end of a metal shaft.

***TX / TY rings fit shafts from .094 inches to 1 inch in diameter.
DTX rings fit shafts from 1.5mm to 45.0mm in diameter.***

Self-Locking Retaining Rings

Internal, TI

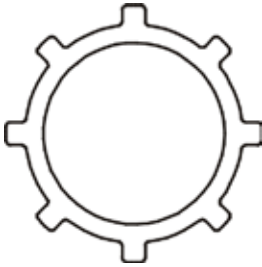

Toothed Internal “Push on” ring. The internal version of the TY features a series of prongs protruding outward. The ends create interference with the housing when the ring is installed and a load introduced to the other side.

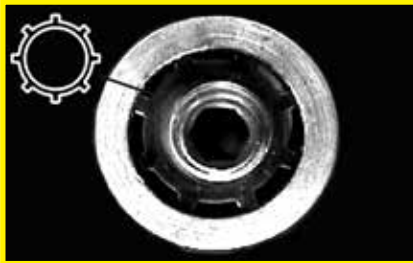

TI-internal ring retains an assembly in a bore.



*TI rings fit housings from .312 inches to .938 inches in diameter.
DTI rings fit housings from 8.0 mm to 50.0mm in diameter.*

Self-Locking Retaining Rings

External, RG



External Radial Grip ring. This radially installed ring makes its own groove on a soft shaft, which significantly increases its holding power. It can also be installed directly against the face of the retained part, virtually eliminating endplay. Automate installation using a Rotor Kick, Jr. Pneumatic installation tool. (Note: this product works only on “soft” shafts).



RG-grip rings retain sections of this security gate.

RG rings fit housings from .092 inches to .379 inches in diameter.

Self-Locking Retaining Rings Assembly Tools

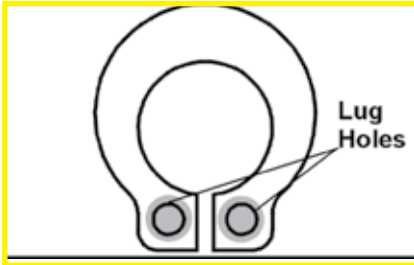

The only self-locking retaining ring with lug holes is the SHF. A Rotor Clip retaining ring plier can be used to install this ring on a shaft using these holes.

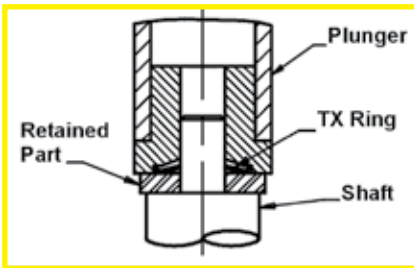

For TX, TY Rings, a cylindrical plunger can be easily made. The ring is positioned at the opening of the plunger and then pushed or tapped onto the shaft, as illustrated.



The RG retaining ring is installed using a Rotor Kick, Jr. Automatic installation tool.



Designed to comfortably fit in the palm of your hand, the lightweight TX Easy Guide allows you to painlessly install Rotor Clip's TX self-locking retaining rings.

**For installation of TI Retaining Rings
call 1-800-55-ROTOR, ask for Technical Sales or
e-mail tech@rotorclip.com.**

Self-Locking Retaining Rings

Summary

1. They save machining time and overall costs since a groove is not needed for installation.
2. They come in small sizes (some fitting shafts as small as .058" in diameter) and can be used effectively and economically on small applications with very low thrust loadings.
3. Most are permanent once installed and can not be easily removed.
4. Made to World Standards—Inch, DIN (Metric).



Designation: SHF

Type: External (shafts & pins)

Size Range: .058- .750 inches (1.5-19.0mm)

Description: External SHaft Friction ring. The SHF ring resembles a regular SH ring except that it is designed to function on a shaft without a groove. The design of the ring causes it to exert significant gripping power uniformly on the shaft (except where the gap occurs)



Designation: TX, TY

Type: External, Reinforced (shafts & pins)

Size Range: .094-1.000 inches (2.3-25.4mm)

Description: Toothed eXternal "Push on" ring/ Toothed External (next in series after X) "Push on" ring. This ring features an outer rim with a series of prongs protruding into the center. The ends create interference with the shaft when the ring is installed and a load introduced to the other side. The difference between these two rings is that the outer rim of the TX is curved while the rim of the TY is flat. The curved rim of the TX affords greater thrust load capacity than the TY and is easier to orient for assembly.



Designation: TI

Type: Internal, Circular (housings & bores)

Size Range: .312-.938 inches (7.9-50.8mm)

Description: Teeth Internal "Push on" ring. The internal version of the TY featuring a series of prongs protruding from the center. The ends create interference with the housing when the ring is installed and a load introduced to the other side.



Designation: RG

Type: External (shafts & pins)

Size Range: .092-.379 inches (2.3-9.63mm)

Description: External Radial Grip ring. This radially installed ring makes its own groove on a soft shaft which significantly increases its holding power. It can also be installed directly against the face of the retained part, virtually eliminating end play. Automate installation using a Rotor Kick, Jr. Pneumatic installation tool. (Note: this product works only on "soft" shafts).

Materials / Finishes / Packaging Materials

Standard material for Rotor Clip retaining rings is carbon spring steel (SAE 1060-1090/UNS G10600-G10900). Rings can also be produced in stainless steel (PH-15-7Mo/UNS S15700) and beryllium copper (Alloy #25/UNS C17200).

ST-Carbon Spring Steel (SAE 1060-1090//UNS G10600-G 10900). This is known for its high strength and reliability in retaining ring applications. (Ex. HO-25ST) offering the following advantages-

1. High strength-the heat treating process assures the rings are wear resistant.
2. Ductility-the heat treating process also assures the spring characteristic of the ring enabling it to return to its original shape after it is deformed.
3. Corrosion Protection Option-It is cost effective to plate carbon steel for corrosion resistance.

BC-Beryllium Copper (Alloy #25/UNS C17200), for applications where the ring must be non-magnetic and conduct electricity. It is also characterized by excellent corrosion resistance and is particularly effective in sea air and sea water applications (Ex. HO-25BC). This is a useful material when the following parameters apply to your application:

1. The ring must be non-magnetic.
2. The ring must conduct electricity.
3. The ring must be highly corrosion resistant to sea air and sea water.

SS-Stainless Steel (PH-15-7Mo/UNS S15700). An extra strength, corrosion resistant steel, capable of preventing atmospheric oxidation at temperatures up to 1000° F. It is also effective for applications where the rings need protection in extremely corrosive atmospheres like sea water (Ex. HO-25SS). Other features include:

1. Minimal distortion due to precipitation hardened condition RH 950.
2. A minimum of 225,000 psi for high ultimate tensile strength.
3. High creep strength.
4. Highest temperature limit of standard materials (900° F).

NOTE:

ROTOR CLIP RESERVES THE RIGHT TO SUBSTITUTE PH 17-7 STAINLESS STEEL MATERIAL FOR PH 15-7Mo ON LARGER RINGS.

Materials / Finishes / Packaging Materials

STAINLESS STEEL TYPE 420 - A less expensive alternative to PH 15-7. Since general corrosion resistance for this material is less than PH 15-7, use of this material depends on the application. Contact Rotor Clip Technical Sales for assistance.

COPPER ALLOY C72900 - A less expensive alternative to Alloy #25 offering the following characteristics:

1. Excellent high temperature stress relaxation resistance
2. High strength and excellent formability
3. Lack of distortion during aging

Contact Rotor Clip Technical Sales regarding use of this material.

PHOSPHOR BRONZE ALLOY #5218 -The least expensive copper material Rotor Clip offers. This type exhibits higher strength compared to standard phosphor bronze materials with the same tin percentages. It is also characterized by very good stress relaxation characteristics. (Note: Rotor Clip can also supply phosphor bronze material to DIN standard 17 662, Material Number 2.1020. Contact Rotor Clip Technical Sales for more information).

Materials / Finishes / Packaging Finishes

PHOSPHATE COATING (PA)

This standard finish is recommended over unfinished plain steel since it offers an extended shelf-life protection against rusting.

THERE IS NO ADDITIONAL CHARGE FOR THIS FINISH.

PHOSPHATE AND OIL (PD)

This finish provides 8-hour salt spray protection.

Materials / Finishes / Packaging Finishes

HEAVY PHOSPHATE AND OIL (HPD)

This finish provides 72 salt spray hours and can be used in place of costly stainless steel material in some applications. (Contact Rotor Clip Technical Sales for more information).

PHOSPHATE WITH SEALER (PAL)

A coating is added to the finish to control loose phosphate crystals on the surface of the part.

ZINC PLATING (ZD)

This coating features a yellow dichromate post plating finish. It affords the metal excellent salt spray protection (96 hours) and is particularly effective for applications exposed to seawater. Rotor Clip SAE 1060-1090 steel retaining rings are zinc plated using a mechanical plating process, which effectively eliminates hydrogen embrittlement.

ZINC BRIGHT (ZF)

Most of the dichromate is leached out of this process, leaving a "bright" silver finish on the parts. ZF offers some corrosion protection (48 hours), but is widely used when the aesthetics of the part are a factor.

ZINC DICHROMATE WITH SEALER (ZDL)

This improved finish offers corrosion protection of up to 240 hours of salt spray protection. (Heavy Zinc Dichromate with Sealer - HZDL - offers 480 hours of salt spray protection.) It is a low cost substitution for costly non-corrosive materials such as stainless steel in some applications. Call for additional information.

TRIVALENT COATING(Z3X)

This coating meets global requirements for hexavalent-free coatings, and Rotor Clip is working with the automotive industry to write new standards for its use with retaining rings. Z3X (trivalent with sealer) offers 240 salt spray hours of protection.

Contact Rotor Clip Technical Sales for more information.

Materials / Finishes / Packaging Packaging

ROTOR CLIP Parts are packaged one of four ways:

Bulk-No Code. The parts are packed in varying size boxes or bags depending upon the size of the part. If a part is ordered bulk, there is no code listed after the finish. For example, HO-25ST PA would indicate that the part is to be shipped bulk.

S-Stacked. This suffix indicates that the parts are to be stacked. This means that the rings are stacked on top of one another, using automated equipment, and taped in that position. The resulting cartridges can be used to feed automated assembly equipment for easier, more efficient installation of the rings. (EX-HO-25ST PA S)

For your information, only the following rings are offered stacked: E, DE, ME, MRE, JE, C, DC, MC, RE, HO, DHO, MHO, HOI, VHO, RG, and PO/POL.

R01-Plastic Shrink Wrapped. Rings are shrink wrapped instead of tape stacked. This is particularly useful on Phosphate & Oil (PD) or other oiled parts in which tape will not stick.

Rings On Wire (ROW). Rings on Wire offer the following advantages:

1. Eliminates Mixed Parts
2. Eliminates Sorting
3. Reduces Handling
4. All Parts Are Burr Oriented
5. Beveled Parts Will Be Properly Oriented On The Stack
6. Yields A Flatter Part

There is no additional charge for Rings On Wire (ROW) packaging. ROW is standard bulk packaging for certain rings. Contact factory

for more details.



Packaging-1M piece bags.



Tape Stacked Retaining Rings-S



40 Shrink Wrapped Parts (R01)



Rings On Wire (ROW)

Breaking The Code

All Rotor Clip retaining rings are identified by a nomenclature that tells you what type of ring it is, the material from which it is made, the finish, and how it is to be packaged for shipment to you. Let's take a look at an example and review the different codes representing the various Rotor Clip part numbers:

HO	25	ST	PA	S
TYPE	SIZE	MATERIAL	FINISH	PACKAGING

TYPE

The above is a complete part number with codes. The first part identifies the type of ring. In this example, "HO" is for "Housing". This means that the ring is an internal HO.

HO	25	ST	PA	S
TYPE	SIZE	MATERIAL	FINISH	PACKAGING

SIZE

Next is the size designation. This number divided by 100 will give you the nominal diameter of the shaft or housing. In this example, the ring is for a housing $\frac{1}{4}$ " in diameter (25/100). The sizes for all rings are listed in the specification pages of the Rotor Clip catalog.

Breaking The Code

HO

TYPE

25

SIZE

ST

MATERIAL

PA

FINISH

S

PACKAGING

MATERIAL

This code refers to one of these material options.

Material	Specification	Rotor Clip Code
Carbon Spring Steel	SAE 1060-1090 (UNS G10600-G10900)	ST
Stainless Steel	PH 15-7 Mo (Grade 632 - UNS S15700)	SS
	17-7 PH (Grade 631 - UNS S17700)	SS*
	420 (UNS S42000)	SA
Beryllium Copper	UNS C17200	BC
Phosphor Bronze	UNS C52180	PB
Copper Alloy	Copper Alloy C72900	PF

*Note: Large stainless steel rings may be supplied from 17-7 due to material availability. Contact factory for details.

See pages 37 and 38 for a more detailed material description.

Breaking The Code

HO	25	ST	PA	S
TYPE	SIZE	MATERIAL	FINISH	PACKAGING

FINISHES

Determine the right finish for your application as follows:

Finish	Code	Description	Salt Spray Hours	Color
Phosphate	PA	Shelf-Life	-	Black
	PD	Phosphate and Oil	8 (Red Rust)	Black
	PAL	Phosphate with Sealer	-	Black
	HPD	Heavy Phosphate and Oil	72 (Red Rust)	Black
Hexavalent Chrome	ZF	Zinc Bright	48 (Red Rust)	Silver
	ZD	Zinc Dichromate	96 (Red Rust)	Yellow
	ZDL	Zinc Dichromate Sealer	240 (Red Rust)	Yellow
	HZDL	Heavy Zinc Dichromate Sealer	480 (Red Rust)	Yellow
Trivalent	Z3X	Trivalent Zinc plus Sealer	96/240*	N/A
Optional Color Coding Finishes	ZFF	Zinc Flash	None	Silver
	CF	Copper Flash	None	Copper

* white corrosion / red corrosion

See pages 38 and 39 for a more detailed description of the finishes.

Breaking The Code

HO	25	ST	PA	S
TYPE	SIZE	MATERIAL	FINISH	PACKAGING

PACKAGING

CODE	PACKAGING
No Code	Bulk
S	Stacked
R01	Plastic Shrink Wrapped

For your information, only the following rings are offered stacked: E, DE, ME, MRE, JE, C, DC, MC, RE, HO, DHO, MHO, HOI, VHO, RG, and PO/POL.

NOTE: Order in multiples of 1,000 pieces for rings up to 1" in diameter and get fast delivery of your order.

See page 40 for a more detailed packaging description.

Design Considerations

Reduce your fastener assembly costs by designing in a Rotor Clip Retaining Ring. Consider replacing costly traditional fasteners with retaining rings and enjoy savings you didn't know were possible. ROTORCLIPS® can also handle many "Non-Traditional" fastener requirements for even greater savings. Before you designate a ROTORCLIP® for your application, follow these simple steps.

STEP 1 - DETERMINE THE RING TYPE



If the assembly you must retain is in a housing/bore, then you need an internal type or HOUSING (HO) ring.



If the assembly you must retain is on a shaft, then you need an external type or SHAFT (SH) ring.

Design Considerations

If you are looking for a retaining ring to act as a spring or as a preload on parts to reduce chatter or vibration, then you need either a bowed (BHO, BSH for resilient end-play takeup) or a beveled (VHO, VSH for rigid end-play takeup) retaining ring. These are available for both internal and external applications.

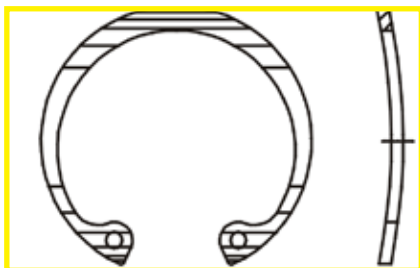

There are two other important variations of both HO internal rings and SH external rings. The "Bowed" HO (BHO)...

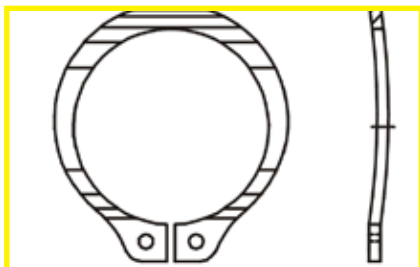

...and "Bowed" SH (BSH), so named because they are shaped like a bow, are used to compensate for accumulated tolerances.

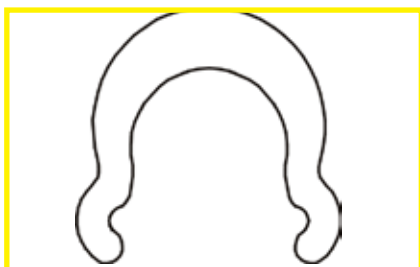

Rotor Clip RG "Radial Grip Ring.

If the assembly you must retain is characterized by very little thrust load, consider a self-locking retaining ring. These require no groove and are ideal for use on shaft/housing diameters of 1" or less.

Design Considerations

STEP 2 - INSTALLATION CONSIDERATIONS - AXIAL VERSUS RADIAL

How the ring is to be installed will effect the type of ring you select. If installation is axial, (along the axis or center point of a shaft/housing), you will need an Axial Retaining Ring. These include HO, SH, HOI, SHI, SHR, SHM rings listed in the axial ring section of the catalog.

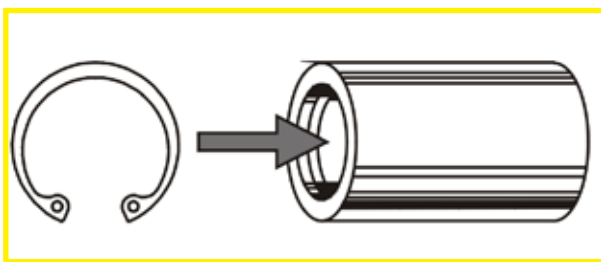

Axial, along the centerpoint of a shaft or housing.

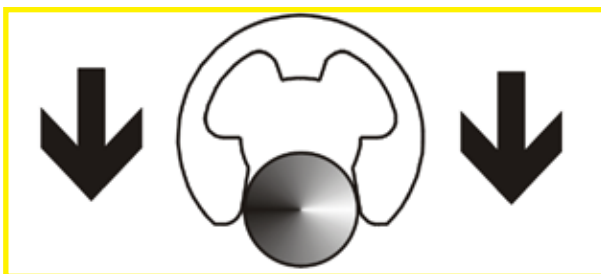

If installation is radial, (along the radius of a circle), you will need a Radial Retaining Ring. These include E, RE, C, PO/ POL, LC rings listed in the radial section of the catalog.

Design Considerations

STEP 3 - RING SIZE

Measure the diameter of the housing or shaft. This dimension will give you the size retaining ring you will need. Note: Rotor Clip retaining rings are made to Inch, DIN, and ANSI Metric standards. "E" retaining rings are also available to JIS (Japanese) standards.

STEP 4 - MATERIAL / STEP 5 - FINISHES

Select the right retaining ring material for your application.

Note: See Materials/Finishes/Packaging Section

STEP 6 - INSTALLATION TOOLS

1. This important step is all too often overlooked. Selecting the right tool for your assembly needs should be a high priority. Don't wait until your rings are delivered before looking into installation issues.

2. Rotor Clip retaining rings can be installed using any of a variety of manual and automatic tools, including pliers and pneumatic tools for axial retaining rings, and applicators and dispensers for radial retaining rings. Many of these feature ergonomic designs that reduce the risk of Carpal Tunnel Syndrome. Avoid using fingers, hammers and makeshift devices as these can cause injury as well as damage to the application.

Design Considerations

3. For high volume installation, consider building your own automated assembly equipment. BEFORE STARTING ON SUCH A PROJECT, HOWEVER, REFER TO OUR AUTOMATED ASSEMBLY GUIDE FOR SOME IMPORTANT INFORMATION. (Help is also available from our experienced technical sales staff).

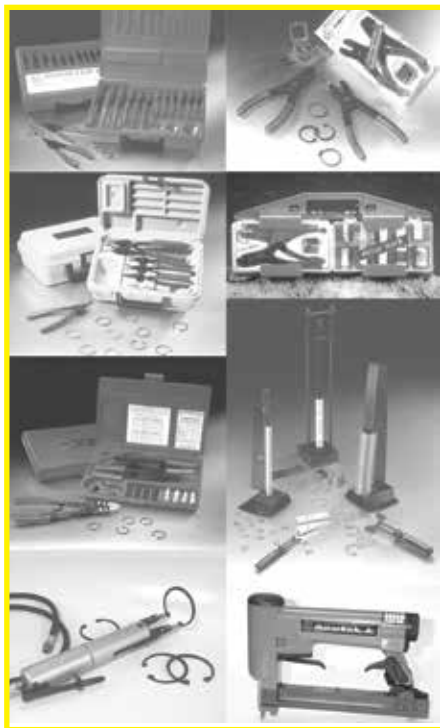

Rotor Clip makes a variety of manual and automatic tools for efficient installation of retaining rings.



Design Considerations

STEP 7 - PACKAGING

Rotor Clip retaining rings can be supplied in the following four ways:

1. Bulk, No code, packaged in varying size boxes or bags depending upon the size of the part. If your part is to be installed using a manual or pneumatic installation tool, this will probably best suit your needs.

2. Stacked (S), meaning the rings are stacked on top of one another, using automated equipment, and taped in that position. The resulting cartridges can be used to feed automated assembly equipment for easier, more efficient installation of the rings.

For your information, the following RotorClips® are offered stacked: E, ME, DE, MRE, JE, C, DC, MC, RE, HO, DHO, MHO, HOI, VHO, RG, and PO/POL.

(Note: Stacked HO internal retaining rings eliminate the time workers must spend untangling the bulk version of these parts)

3. R01-Plastic Shrink Wrapped. Rings are shrink wrapped instead of tape stacked. This is particularly useful on Phosphate & Oil (PD) or other oiled parts in which tape will not stick.

4. Rings On Wire (ROW).

Rings on Wire offer the following advantages:

1. Eliminates Mixed Parts
2. Eliminates Sorting
3. Reduces Handling
4. All Parts Are Burr Oriented
5. Beveled Parts Will Be Properly Oriented On The Stack
6. Yields A Flatter Part

There is no additional charge for Rings On Wire (ROW) packaging. ROW is standard bulk packaging for certain rings. Contact factory for more details.

EXAMPLE

Based on steps 1-7, you conclude that your application calls for retaining an assembly in a housing, where end-play is not a problem. The housing diameter is .500". Installation will be in an axial direction. Material will be carbon spring steel, with a Zinc Dichromate Finish, since corrosion protection will be a factor in preserving your assembly from rust.

The catalog calls out an axially installed HO-50. Since installation will be manual, you select an RP-100 retaining ring plier as the primary installation tool. Bulk packaging will be sufficient.

You now have all the specifications related to that ring listed in the catalog. Be sure to review them carefully.

Other Considerations

I. Standard Versus Custom

Selecting a standard retaining ring will always be more cost effective than designing a custom retaining ring. It will also save on engineering time, eliminate production problems and ensure timely delivery of product. A Rotor Clip technical sales engineer can help you find a suitable standard replacement for a custom retaining ring.

II. Standard Versus Inverted

If you have another assembly that must pass through the housing of your application. Check the Clearance Diameters "L1" and "L2" dimensions. This will tell you if the lugs of the ring will interfere with this assembly. If this is the case, you can switch the ring to an HOI (HOUsing Inverted) (or SHI SHaft Inverted for a shaft application). This ring features inverted lugs for better clearance.

Other Considerations

III. Axial Versus Radial

If your application can accept either an axial or a radial retaining ring, shoulder size, thrust load and RPM may determine which type you use. Be sure to check these specifications carefully before making your selection. (Keep in mind that radial rings offer enlarged shoulders for part retention and generally cost less than standard axial rings).

IV. E Versus RE Rings

If you select an E ring and later discover that it can not withstand the RPM generated by your application, you can change it to a standard RE ring. RE rings fit into the same grooves as E rings and can be easily interchanged without re-designing the application.

V. Different E Ring Designations

The "E" ring specification pages in the Rotor Clip catalog list many variations. For example, E-18, SE-18, YE-18 and ZE-18 are not "specials" but simply different parts that can be used on the same shaft size. They will function in applications having either different groove diameters/groove depths for the same size shaft (3/16"). They also offer optional geometry for a specific shaft size. Often, the O.D., ring thickness and groove dimensions vary for SE, YE and ZE part numbers.

VI. PO Versus POL

This ring series offers a similar advantage as the E and RE. The PO is complemented by a "light duty" series known as POL that is thinner than the standard PO rings.

VII. SH Versus SHR

An SHR is a heavy duty version of an SH ring with increased thickness and minimum/maximum sections that will give you increased thrust load and RPM limits. Keep in mind that an SHR requires a wider groove than an SH before you make the switch.

VIII. Duplicate Ring Designations

Some retaining rings are listed twice in the catalog (Ex. HO-156). This means that the same ring will function in two separate applications that have different housing/shaft and groove sizes.

Other Considerations

IX. Common Measurements

A. Free Diameter, Axial Rings—This dimension can only be measured accurately on rings that have never been installed. Measuring free diameter on an HO ring where the lugs have been compressed (or on an SH ring where they have been expanded) will yield a false reading.

B. Free Diameter, E Rings —Do not take this measurement on an E ring using a caliper. The correct way is to use a pin gauge that makes three point contact with the ring's prongs.

C. Free Diameter, Inverted Rings—The standard way of measuring free diameter for an axial ring does not hold true for an HOI and SHI retaining ring. For the correct method, see the HOI and SHI catalog specification pages.

D. Hardness—To check hardness effectively, you must first remove any finishes from both sides of the ring. Using a properly calibrated hardness tester, take a reading on the ring with the burr side up. Compare results to those listed in the hardness tables of the catalog specification page for that ring.

X. Installation Considerations

An external axial ring (SH, SHI, etc.) can be over expanded during installation. To prevent this, take a pin gauge 1% larger than the nominal shaft diameter of your application. Using a Rotor Clip retaining ring plier and safety goggles, expand the ring and release it on the gauge. With the tips still in the lugs, adjust the stop to this opened condition.

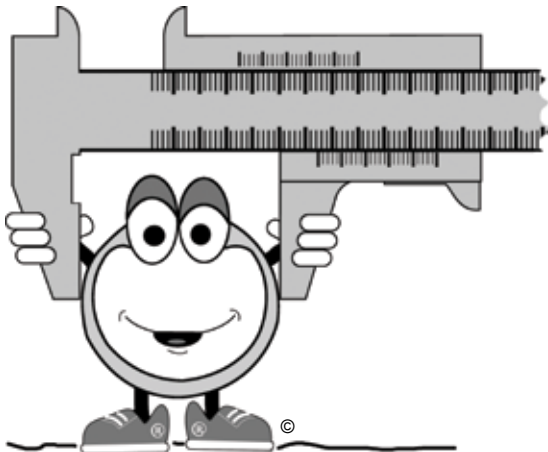

Automated Assembly

AXIAL RETAINING RINGS

Automated Assembly is used in the manufacturing process as a cost reduction tool that additionally achieves increased production rate and added quality through repeatability. The same holds true for automated assembly of retaining rings. Parts can be assembled fast, reducing costs without sacrificing quality. Properly designed installation equipment shuttles the ring into the groove without disruption and guards against permanent set (overstretching/over compressing of ring) to ensure a tight fit.

Design Considerations

Feed equipment should be designed to work with rings meeting standard specifications. Most critical is to design equipment that can accommodate the helix and pitch limitations for the type of ring you are using. If the equipment is sensitive to any of these factors, it will require special processing that will add to your costs. Design guidelines include:

1. Consider use of a tapered mandrel for external retaining rings and a tapered housing for internal retaining rings (*see illustrations page 55*). It is not recommended to pick up and transfer rings by the lug holes.

Automated Assembly

AXIAL RETAINING RINGS

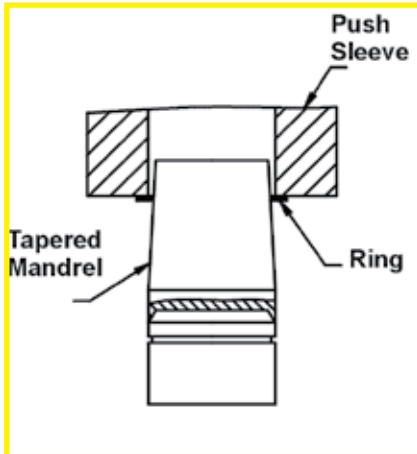

EXTERNAL- Use tapered mandrel to expand ring and install in groove on shaft. (Note: angle of inclination of taper should be 3-5 degrees).

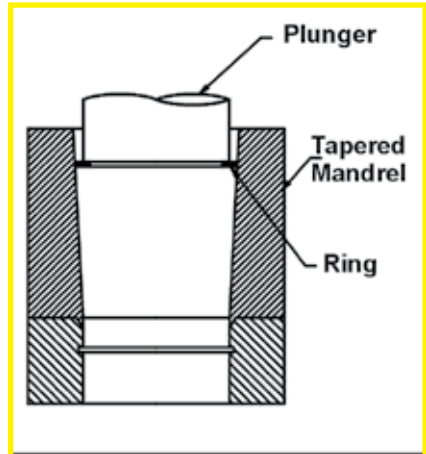

INTERNAL -Use tapered housing to compress ring and install in groove in housing. (Note: angle of inclination of taper should be 3-5 degrees).

2. Feed parts onto the tapered mandrel or into the tapered housing using a "feed finger" mechanism. Make sure the rings are fed in the proper direction and in the proper manner as depicted to avoid sensitivity to ring pitch.

3. Feed finger thickness should be sized per ring: 80% of the ring minimum thickness. (For example: If ring thickness is .025" +/- .002, feed finger should be .018" thick -- $.023 \times 80\%$.)

4. Limit shuttle distance to a minimum from feed mandrel to installation on assembly.

Automated Assembly AXIAL RETAINING RINGS

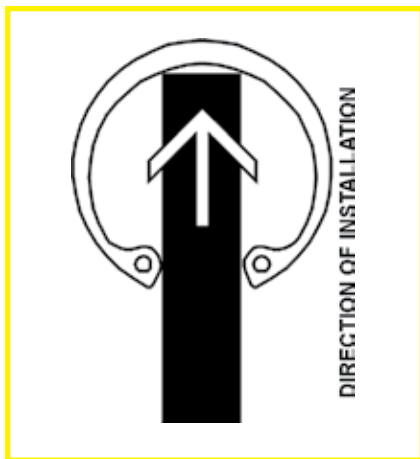

Figure A - This is the preferred way to transfer feed an internal ring into a tapered housing by inserting the mechanism between the lugs (Note: Finger thickness should be 80% of the minimum ring thickness).

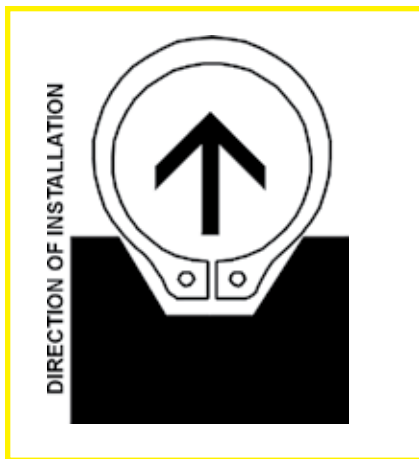

Figure B- This is the preferred way to transfer feed an external ring onto a tapered mandrel by using a slide with a complementary cut out for the lugs. (Note: Finger thickness should be 80% of the minimum ring thickness).

5. Do not incorporate extension sleeves to tapered mandrel/tapered housing. This may exceed the expansion/compression limits of the ring causing it to fail. (Note: extension sleeves are typically used to guard against scratching/marring the finish of the shaft or housing. If this is a concern, please consult Rotor Clip Technical Sales).

6. Incorporate complementary chamfers to the assembly and installation mandrels.

Identifying Retaining Rings

You find yourself staring at a twisted piece of metal you have just extracted from a housing/bore or a shaft. About the only thing certain is that the object in the palm of your hand is a retaining ring. You now have to identify the type and size so that you can replace it. But given the condition of the part, that seems impossible.

Don't groan just yet; there is a solution.

With the help of this training booklet, you have a reasonable chance of identifying the ring.

If your ring looks like one of these:



... you have an AXIAL retaining ring.

If your ring looks like one of these:



... you have a RADIAL retaining ring.

FOLLOW THESE STEPS FOR AXIAL RETAINING RINGS

1. Measure the inside diameter of the housing (or the outside diameter of the shaft) from which the ring came using a caliper ("Housing-Dh/Shaft-Ds" dimension in the catalog). Record your result. (If you're not sure how to use a caliper/micrometer, see the end of this section.)

Identifying Retaining Rings



Caliper measuring housing.



Caliper measuring shaft.

2. Measure the thickness (dimension "T" in the catalog). Record your result.

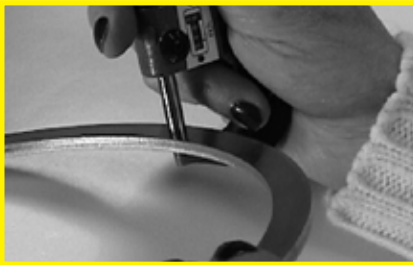

Micrometer measuring thickness (T).

3. Measure the lug height as shown (dimension "H" in the catalog). Record your result.



Measuring lug height (H) on an SH Retaining Ring.



Measuring lug height (H) on an HO Retaining Ring.

Identifying Retaining Rings

4. Measure the maximum section of the ring and/or the minimum section as shown (Dimensions "S max" and "S min" in the catalog). Record your result.



Measuring S max on an HO Retaining Ring.



Measuring S min on an HO Retaining Ring.

Go to Rotor Clip's Catalog and Engineering Manual and match the ring you are trying to identify to the ring drawings listed. Proceed to the specification pages for that ring. Next, match the dimensions you have taken above to the equivalent specs listed on that page. Read the type and size ring that matches those dimensions (EX. HO-25, SH-50, etc.)

It may not be possible to take every dimension listed above. However, one or two may be sufficient in helping you identify the ring.

FOLLOW THESE STEPS FOR RADIAL RETAINING RINGS.

1. Measure the outside diameter of the shaft from which the ring came using a caliper ("Ds" dimension in the catalog). Record your result. (If you're not sure how to use a caliper, see next section).

Identifying Retaining Rings

2. Measure the "Outside Diameter" (dimension "G" in the catalog), using a caliper. Record your result.



Caliper measuring outside diameter of ring

3. Measure the thickness (dimension "T" in the catalog). Record your result.



Micrometer measuring thickness (T) of PO (Poodle) ring.

Go to Rotor Clip's Catalog and Engineering Manual and match the ring you are trying to identify to the ring drawings listed. Proceed to the specification pages for that ring. Next, match the dimensions you have taken above to the equivalent specs listed on that page. Read the type and size ring that matches those dimensions (EX. C-25, RE-50, etc.)

***NOTE: If the ring was previously used the "Outside Diameter" dimension will be slightly larger than the listed catalog value. Take this into consideration when trying to identify a ring.**

How To Use a Caliper

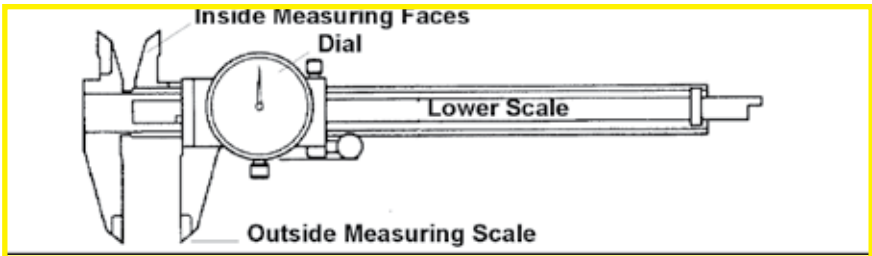

I. Instrument Usage

A. Measure on the outside measuring faces and the inside measuring faces only. The depth measuring blade and step measuring faces are not utilized.

II. Zero Instrument

A. Prior to use, check that the instrument reads zero. This is done by sliding the gage until the outside measuring faces are in contact. If the instrument does not read zero clean the outside measuring faces with paper and attempt to zero again. If the instrument does not read zero after cleaning, have the instrument serviced.

III. Measuring Using the Scale

A. Each ten graduation on the lower scale reads one inch. These graduations are numbered from one (1) to six (6). Count the number of these intervals to determine inches.

Example:

a) 5 = 5 inches

B. Each graduation past the inch on the lower scale reads one tenth of an inch (.100). Count the number of these intervals and multiply by .100.

Example: $4 \times .100 = .4$ (four tenths of an inch)

Add this to the previous result:

$$5 + .4 = 5.400$$

C. Every ten graduations on the dial reads ten thousandths. Each of these intervals are marked from zero (0) to ninety (90). Read the number the dial is on or has passed and multiply it by .001.

Example: $60 \times .001 = .060$ (sixty thousandths of an inch)

Add this to the previous result:

$$5.400 + .060 = 5.460$$

D. Each graduation on the dial reads one thousandth. Each of these intervals are graduated and unmarked. Count these intervals and multiply by .001.

Example: $7 \times .001 = .007$ (seven thousandths of an inch)

Add this to the previous result:

$$5.460 + .007 = 5.467$$

How To Use a Micrometer

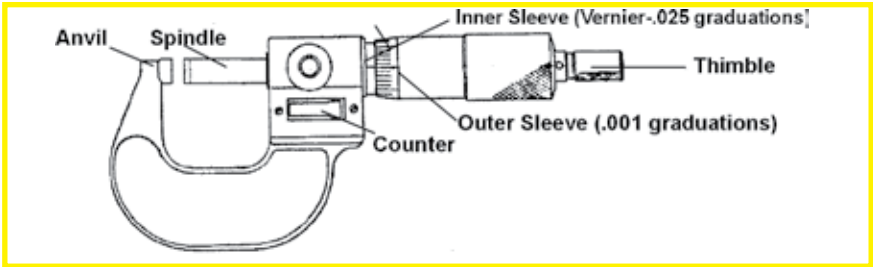

1. Zero Instrument

1.1 Prior to use, check that the instrument reads zero. This is done by turning the thimble until the anvil and spindle come into contact. If the instrument does not read zero clean the faces of the anvil with paper and attempt to zero again. If the instrument does not read zero after cleaning notify your supervisor or the Calibration Technician.

2. Measuring Without Scale

2.1 The instrument counter displays the reading to an interval of one thousandth. To measure to tenth of a thousandth the vernier scale must be used.

3. Measuring Using the Scale

3.1.1 Each graduation on the reference line past zero is twenty five thousandths (.025). Count the number of these intervals and multiply by .025.

3.1.1.1 Example: Three (3) graduations (not counting the zero)
 $X .025 = .075$

3.1.2 Each graduation on the outer sleeve past the reference line represents one thousandth (.001). Read the corresponding number on the outer sleeve and add it to the value determined in 3.1.1.

3.1.2.1 Example: the graduation numbered 6 indicates six thousandths of an inch (.006)
 $.075 + .006 = .081$

3.1.3 Each graduation on the inner sleeve facing the user when holding the micrometer vertically are used to read tenths of thousandth. Choose the corresponding number in which the graduation lines up with a graduation on the outer sleeve and add it to the value determined in 3.1.2.1.1.

3.1.3.1 Example: the graduation number 4 indicates four tenths of a thousands of an inch (.0004) $.081 + .0004 = .0814$

THE ROTOR FILES

Facts, formulas and other technical information about retaining rings for the design engineer.

FORMULAS / CALCULATING EDGE MARGIN

The distance from the groove to the end of the shaft or housing is known as edge margin.

Edge margin is a calculated distance based on the relationship between the edge margin (y) and the groove depth (d). When $y/d \geq 3$, the groove will withstand the maximum thrust load as indicated in the Rotor Clip catalog specification page for that particular size and type of retaining ring.

Example: SH-50 external retaining ring installed on a cold-rolled steel shaft. The catalog specifications for this ring call for a minimum edge margin of 0.048" and a groove depth of 0.016."

Our formula is as follows:

$$Y/d \geq 3 \qquad \frac{0.048''}{0.016''} = 3$$

There is sufficient edge margin for the groove to withstand the maximum thrust load of 550lbs. listed in the catalog specifications.

If an application requires an edge margin less than the recommended specifications, it is necessary to calculate the thrust load (P_g), capacity of the groove, to determine if the reduced margin is capable of handling the anticipated thrust load. The following formula applies (Note: see Correction Factors table for G_f value; Yield Strength of Groove Material for σ_y value; Edge Margin Graph for K_1 value; Nomenclature Table for remaining catalog specifications in the Rotor Clip catalog.)

$$P_g = \frac{G_f D_s d \pi \sigma_y}{K_1 F_s}$$

For this example, assume that the edge margin will only be half the listed catalog value or, $y/d=1.5$. The above equation is as follows:

$$P_g = \frac{(1) .5 \times .016 \times 3.14 \times 45,000}{2.20 (2)} = \frac{1130.4}{4.40} = 256.9 \text{lbs.}$$

Maximum Thrust Load for the reduced edge margin

THE ROTOR FILES

FORMULAS/BEVELED RETAINING RINGS

Beveled rings are designed to function in the groove when positioned within a range of seating depths from the bottom of the groove (maximum insertion) to a recommended position of half way up the groove depth (minimum insertion). The complementary groove and ring bevel allow the ring to function like a wedge when it makes contact with the retained part. The ring exerts an axial force against the retained part, taking up the play and, consequently, reducing the clearance between parts to zero.

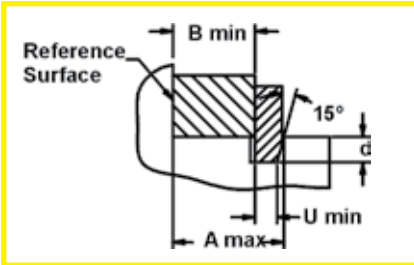

Figure 1—Maximum insertion of a beveled retaining ring.

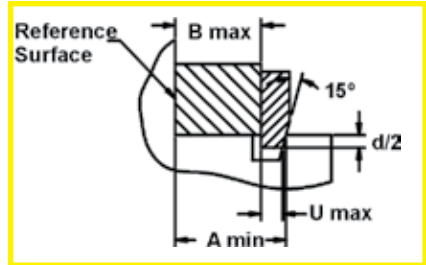

Figure 2—Minimum insertion of a beveled retaining ring.

If the sum of the assembly tolerances consisting of the retained part width (B), the groove location (A) and the ring beveled edge (U) exceed the end play take-up capacity of the ring, two conditions may potentially occur:

1. The ring will be seated less than half way down the groove depth, compromising the thrust load capacity of the assembly.
2. The ring will be seated at the groove bottom and play will be present.

GROOVE LOCATION (REFER TO THE ABOVE DRAWINGS)

The outer groove wall with the beveled edge locates the groove. The distance from a fixed shoulder to the outer beveled groove wall is A. The machining tolerance associated with locating the groove is ΔA . The width of the retained part/parts is B. U is the beveled thickness at the base of the bevel and is specified in our VHO and VSH specification tables.

THE ROTOR FILES

DETERMINING RING FEASIBILITY

The feasibility of a beveled ring should be evaluated first. The built-up tolerances of the system must be less than or equal to the take-up capacity of the ring. For example: A bearing must be retained on a 3" shaft using a VSH-300 Rotor Clip retaining ring. The bearing width is 1.000/0.995. Before the location can be determined, we would need to know the acceptable machining tolerance (ΔA), which we will designate as $+0.003/-0.000$ for the sake of this example. Compute the sum of the tolerances:

$$\begin{aligned}\Delta B \text{ (Bearing Width Tolerance Range)} &= B_{\max} - B_{\min} && .005 \\ \Delta A \text{ (Acceptable Machining Tolerance Range)} &= A_{\max} - A_{\min} && .003 \\ \Delta U \text{ (Beveled End Thickness Tolerance Range from catalog spec)} &= U_{\max} - U_{\min} && .004 \\ &&& \Sigma \Delta = .012\end{aligned}$$

The sum of the tolerances is less than the take-up capacity of the ring (.0135), confirming the fact that the ring will in all assemblies seat within the acceptable limits of half way down to all of the way down the groove.

COMPUTING GROOVE LOCATION

The following equations determine the distance from the defined shoulder (plane of reference) to the top of the far groove wall (A):

$$A_{\min} \geq B_{\max} + U_{\max} / 2 \tan 15^\circ \text{ (Corresponding to minimum groove engagement)}$$

$$A_{\max} \leq B_{\min} + U_{\min} + d \tan 15^\circ \text{ (Corresponding to maximum groove engagement)}$$

Using the values from the above example, we compute A_{\min} and A_{\max} as follows:

$$A_{\min} \geq 1.000 + .073 + .102 / 2 \tan 15^\circ$$

(Note: .073 U value and .102 d value, per catalog spec)

$$A_{\min} \geq 1.087$$

$$A_{\max} \leq .995 + .069 + .102 \tan 15^\circ$$

$$A_{\max} \leq 1.091$$

$$A_{\text{nom}} = (A_{\max} + A_{\min}) / 2 - (A_{\max} - A_{\min}) / 2$$

$$A \Rightarrow 1.089 - .002$$

Reviewing our stack up of tolerances, we assumed .003" for machining. Our calculated groove location allows for more leniency (.004") in the tolerance. Checking the $\Sigma \Delta$ again, we find the assembly is still within the .0135 limit for end play take-up.

From known ring dimensions, retained part dimension(s), required groove depth and designated machining tolerance, the groove can be easily located for assemblies meeting the primary requirement $\Sigma \Delta \leq d/2 \tan 15^\circ$.

ROTOR CLIP LITERATURE

ROTOR CLIP Product Catalog & Engineering Manual

This comprehensive 168-page catalog lists specifications for all Rotor Clip inch, metric, ANSI metric & JIS retaining rings. Also includes inch and metric constant section rings and self-compensating hose clamps. Other engineering information includes edge margin and beveled groove location formulas as well as tips for effective automated assembly of retaining rings. Complete tool information is covered along with descriptions of Rotor Clip's manufacturing, engineering and quality processes. Available in English, Spanish, and German.

ROTOR CLAMP Hose Clamp Brochure

This 12-page brochure lists data for Rotor Clamp's full line of self-compensating hose clamps including single wire, double wire, and constant tension band (CTB) hose clamps. Joint design guide and test data are also included. (Note: Rotor Clamp is the sister company of Rotor Clip Company, Inc.)

Interchange Chart

A two-sided chart interchanges Rotor Clip retaining ring part numbers with those of competitors's part numbers. Also interchanges material & process codes.

Retaining Ring Military Standard Cross Reference Guide

This 24-page brochure interchanges milspec retaining ring numbers with Rotor Clip military part numbers. Includes cross references for carbon steel rings plated with cadmium, zinc, or phosphate coated, as well as passivated stainless steel rings and beryllium copper rings.

ROTOR CLIP Retaining Ring "Quick Size" Wall chart

This 24" X 36" laminated wall chart aids in identifying retaining ring sizes. By sliding the ring along the chart, one can identify external retaining rings (SH) for shaft sizes from 1/2" to 5" in diameter, internal rings (HO) for housing sizes from 1/2" to 5" in diameter.

ROTOR CLIP Retaining Ring "Mini Quick Size Chart"

This 18" X 12" laminated wall chart aids in identifying retaining ring sizes. By sliding the ring along the chart, one can identify external retaining rings (SH) for shaft sizes from 1/8" to 1" in diameter, internal rings (HO) for housing sizes from 1/4" to 1" in diameter, and "E" style external rings for shaft diameters from 5/32" to 1-3/16".

ROTOR CLIP ONLINE

www.rotorclip.com

Here are a few examples of what you can do at www.rotorclip.com:

- Get catalog specifications for our full line of tapered and constant section retaining rings (Inch, DIN Metric, ANSI Metric, JIS standards).
- Cross-reference competitor part numbers to Rotor Clip part numbers.
- Cross-reference milspec retaining ring numbers to Rotor Clip military part numbers.
- Order Samples
- Request Quotes
- Answer a series of questions and let our Interactive Design Guide suggest a ring type for your application. Plus get answers to your questions about retaining rings fast by accessing our on-line version of "RCU"



ROTOR CLIP

CONSTANT SECTION RETAINING RINGS

In addition to a full line of tapered section retaining rings, Rotor Clip also offers a complete line of constant section retaining rings, with many cut-off styles available.

ROTOR CLIP INCH CONSTANT SECTION RETAINING RINGS

INTERNAL INCH CONSTANT SECTION RETAINING RINGS



EXTERNAL INCH CONSTANT SECTION RETAINING RINGS

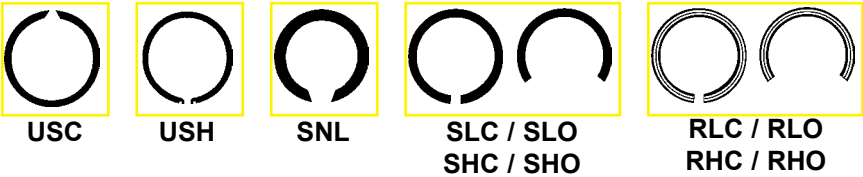

ROTOR CLIP METRIC CONSTANT SECTION RETAINING RINGS

INTERNAL METRIC CONSTANT SECTION RETAINING RINGS

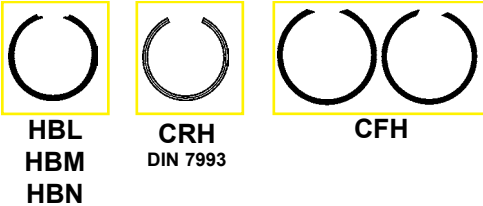

EXTERNAL METRIC CONSTANT SECTION RETAINING RINGS

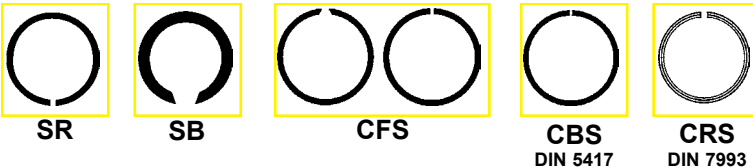

ROTOR CLAMP

SELF-COMPENSATING HOSE CLAMPS

Rotor Clamp Self-Compensating Hose Clamps are easier to install and less expensive than the standard screw/worm type clamps, and are extremely effective for low pressure applications.

Single Wire Hose Clamps (HC)



- Most effective holding force and clamping strength
- Single wire concentrates the clamping force in one specific area around the hose.
- Can be installed with manual and pneumatic tools.
- Application: Appliances (e.g. laundry machines, dishwashers...), Heating and Air- Conditioning, Automotive and Truck Industry, Off-Road Vehicles (e.g. ATV's), Utility Vehicles (e.g. lawn tractors, golf carts), Snowmobiles, Boats and Personal Watercrafts.

Double Wire Hose Clamps (DW)



- Used in applications where a lower clamping force than offered by single wire hose clamps is sufficient and esthetics are important.
- The double wound wire spreads out the clamping force.
- More cost effective than single wire hose clamps.
- Can be installed with manual and pneumatic tools.
- Application: Spa Applications, Appliances (e.g. laundry machines, dishwashers), Heating and Air Conditioning, some Automotive and Truck Industry, Utility Vehicles (e.g. lawn tractors, golf carts).

Constant Tension Light Band Hose Clamp (CTL)

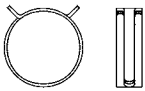

- Easy to install and remove.
- Simple, one-piece design provides leak-proof connections.
- Low cost band clamp with the high quality and reliability of Rotor Clamp.
- Application: Small Engines, Agricultural and Utility Vehicles, Automotive, Appliance.

Constant Tension Band Hose Clamp (CTB)

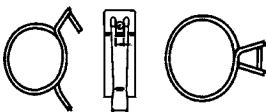

- Easy to install and remove.
- Used in applications where a lower clamping force than offered by single wire hose clamps is needed and esthetics are important.
- Can be installed with manual and pneumatic tools.
- Application: Spa Applications, Automotive and Truck Industry.

ROTOR CLIP: Innovation Every Day.

ROTOR CLIP UNIVERSITY

The Ultimate Retaining Ring Guide
also online at www.rotorclip.com.

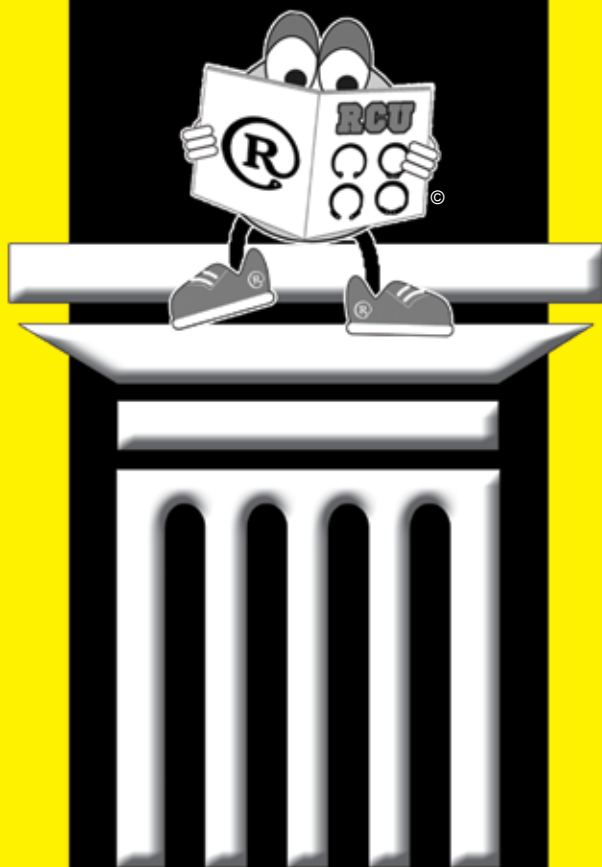

 **ROTOR CLIP COMPANY, INC.**

187 Davidson Avenue, Somerset, NJ 08873
1-800-557-6867 - 732-469-7333 - Fax: 732-469-7898
sales@rotorclip.com - www.rotorclip.com

